

ODU MINI-SNAP[®] SERIES F

HDMI   
ODU HIGH SPEED DATA TECHNOLOGY



ODU MINI-SNAP® F

FEATURES

- Quick and easy mating, locking and demating
- Blind mating and demating in difficult-to-reach places
- Low space requirement on the devices
- Secure locking
- Easy cleaning of the housing
- Standard cable assemblies

APPLICATIONS

- Medical
- Industrial
- Test and measurement
- Military and security
- Automotive



All shown connectors are according to IEC 61984:2008 (VDE 0627:2009:11) connectors without breaking capacity (COC).

ODU MINI-SNAP® is UL-listed under file E110586, fulfils the demands of RoHS (2011/65/EU) and has a licence in accordance to VDE (Reg.-No. 40004941).

All dimensions are in mm.

Some figures are for illustrative purposes only. Subject to change without notice. Errors and omissions excepted. We reserve the right to change our products and their technical specifications at any time in the interest of technical improvement. This publication supersedes all prior publications.

This publication is also available as a PDF file that can be downloaded from www.odu-connectors.com

Issue: 2023-05

Data transmission protocols

The contact arrangement of an ODU data transmission connector differs from a standard data transmission connector due to the robust ODU specific design. However, the ODU design meets the electrical specifications of the respective standard data transmission protocol.

TABLE OF CONTENTS

PRODUCT INFORMATION	5
ODU Circular Connectors Series at a glance	6
Circular connectors with push-pull locking complete with cable assembly	7
The push-pull locking principle of series F	8
Applications and materials	9
CONFIGURATION	11
Step by step to the perfect connection	12
ODU MINI-SNAP® SERIES F	19
Summary ODU MINI-SNAP® Series F	20
Cross-sectional view of the connector	22
Codings	23
Plugs and cable assemblies	24
Receptacles and cable assemblies	40
Contact inserts, cable types and PCB layouts	52
Cable collet system	71
Accessories	72
TOOLS, CRIMP INFORMATION, PROCESSING INSTRUCTIONS	83
Crimping tools / assembly tools	84
Spanner wrench	86
Nutdriver for slotted mounting nut	86
Removal tools for crimp-clip-contacts	87
TECHNICAL INFORMATION	89
International protection classes acc. IEC 60529:1989 (VDE 0470-1:2014-09)	90
Explanation and details of safety requirements, inspections and voltage data	91
Operating voltage	93
Voltage data according to "MIL"	94
Principle of watertightness	95
Housing materials and insulator materials	96
Termination technologies	97
Conversions / AWG	98
International color code / IC-code	99
Current load of turned contacts	100
Electro magnetic compatibility (EMC)	101
Autoclaving of ODU MINI-SNAP®	102
Technical terms	103



ODU MINI-SNAP®



PRODUCT INFORMATION

ODU Circular Connectors Series at a glance	6
Circular connectors with push-pull locking complete with cable assembly	7
The push-pull locking principle of series F	8
Applications and materials	9

ODU CIRCULAR CONNECTORS SERIES AT A GLANCE

	Coding	Size	No. of possible mechanical codings	Plug diameter in mm	Max. cable diameter in mm	Max. number of contacts	Solder	Crimp	PCB	International protection class A ¹	International protection class B ²
	Half-shell	0	3	9.4	5.0	09	●	●	●	up to IP68	up to IP68
		1		12	7.5	14					
		1.5		13	7.5	19					
		2		15	9.5	19					
		3		18	11.5	27					

ADDITIONAL CONNECTORS WITHIN THE ODU CIRCULAR CONNECTOR SERIES:



- Low weight – plastic connector
- Up to IP67
- Push-pull and break-away versions
- Up to 41 contacts
- Autoclavable / sterilisable optional
- High speed data transmission with shielded tunnel
- Standard cable assemblies with UL rated cables and single wires



- Coding over pin and groove
- Up to IP68
- Push-pull and break-away versions
- Up to 40 contacts
- Autoclavable / sterilisable optional
- High speed data transmission versions
- Standard cable assemblies with UL rated cables and single wires



- Tested acc. to MIL
- Up to IP6K9K
- Push-pull, break-away and screw-lock versions
- Up to 55 contacts
- High reliability for harsh environments
- High speed data transmission versions
- Standard cable assemblies with UL rated cables and single wires

¹ International protection class in mated condition. ² International protection class in unmated condition to the end device.

CIRCULAR CONNECTORS WITH PUSH-PULL LOCKING COMPLETE WITH CABLE ASSEMBLY

ODU MINI-SNAP® is the ideal self-locking circular connector for a wide range of applications. Whether used for transmitting power, signals, data or other media, this circular connector in its robust metal connector plug housing impresses customers with its exceptional quality, high reliability and ideal handling characteristics.

The push-pull principle reliably ensures that the connector will not come loose during use: Once plugged in, the ODU MINI-SNAP® locks itself into the receptacle automatically. It cannot be separated by pulling on the cable. Instead, the connector can easily be demated from the receptacle by pulling on the outer housing.

VERSATILE CONFIGURATION OPTIONS

There are 5 sizes, 3 termination types and a great variety of various contact inserts to choose from.

COMPLETE SYSTEM SOLUTIONS

Every connection has a unique cable requirement. Make no compromise when it comes to the quality of the complete interconnect system. ODU gives you the complete system solution from one source, without the need for an intermediary supplier.

Services include:

- + One point of contact for a complete system
- + High technical expertise in the processing of third-party products
- + 100 % final inspection
- + Custom labeling and cable printing
- + Close collaboration with leading cable manufacturers
- + Process-controlled solder and crimp monitoring from initial samples to full production
- + Cleanroom production possible in accordance with ISO 14644-1:2015-12
- + Production in accordance with UL possible (File: E333666)
- + Inhouse Technology Test Center for the development of technologies for customer-specific requirements
- + Production according to IPC standards



THE PUSH-PULL LOCKING PRINCIPLE OF SERIES F

Push-pull locking systems have a **highly user-friendly locking mechanism**. When the connector is mated with the receptacle, the connector's locking fingers (1) will lock into place in the receptacle and form a **dependable connection** between both parts. It **cannot be separated** by pulling on the connector's cable (2). Instead, the connector can easily be demated from the receptacle **by pulling on the outer housing (3)**. The ODU Push-Pull Connectors are available in 5 different standard sizes with diameters from 9.4 mm to 18 mm.



WATCH VIDEO 

ODU MINI-SNAP®
Series F:
locking system

Connector in **unmated** condition.

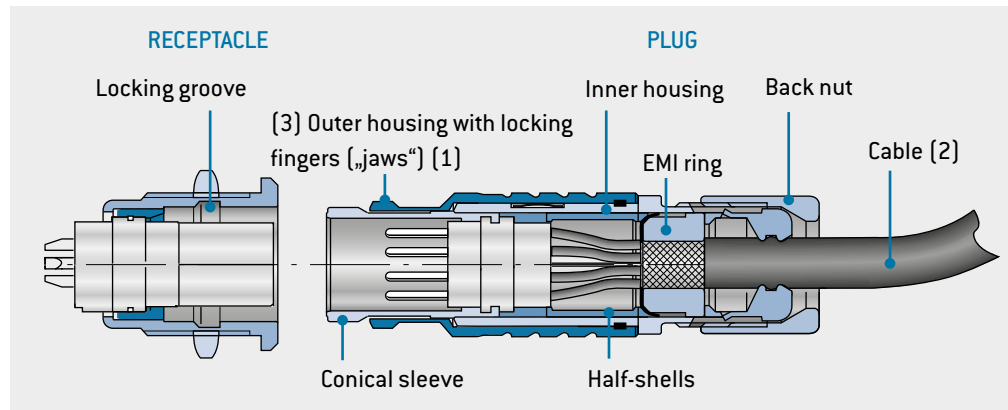

Pulling on the cable or back nut causes the locking fingers to grip harder into the locking groove in the receptacle. This prevents the connector from being disconnected.

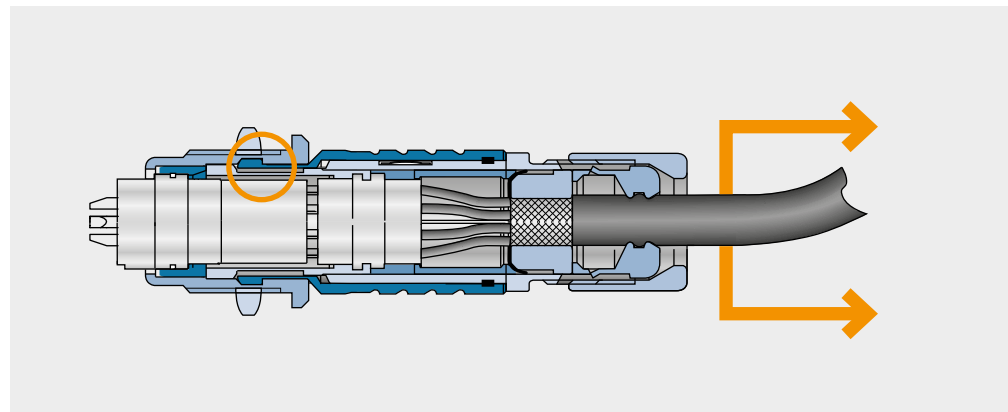

But pulling on the outer housing will cause the locking fingers to emerge from the locking groove, making it easy to disconnect the connector.

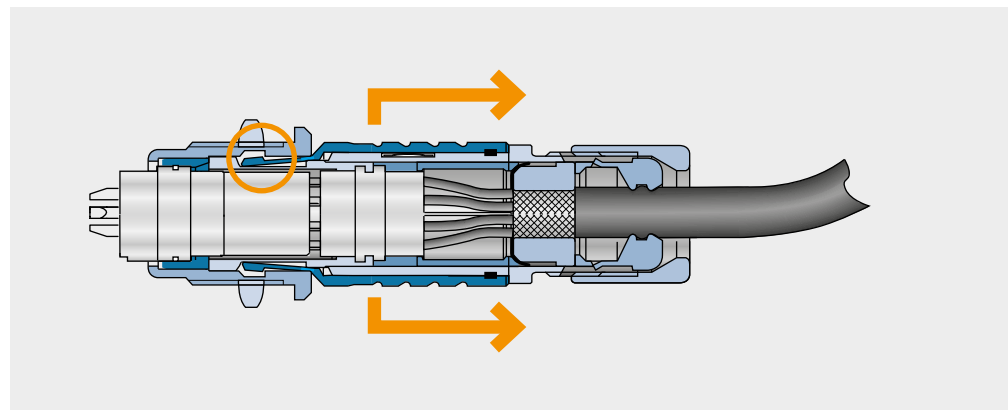

APPLICATIONS AND MATERIALS

The ODU MINI-SNAP® uses PEEK insulator material as a standard feature. Other materials are available upon request. ODU MINI-SNAP® housings are made of brass, nickel plated and then matt chrome plated. Nickel and tin-nickel plated housings are available upon request (not autoclavable). The internal parts are made of nickel plated brass.

Thanks to its versatility and autoclavability (matt chrome), the ODU MINI-SNAP® is used in a wide variety of applications, such as medical, test and measurement, industrial electronics and energy.

The temperature range of ODU MINI-SNAP® under general operating conditions is between -40 °C and up to +120 °C, while autoclavable connectors can even be used at temperatures up to +134 °C (see page [102](#)). For cable assemblies, please see temperature range rating page [17](#).

Turned contacts are available in diameter 0.5 mm to 3.0 mm in the following termination types:

Solder, crimp and PCB

Mating cycles	> 5.000
Material	Cu alloy
Plating	Ni and Au

TERMINATION TECHNOLOGIES

	Plug	Receptacle
Crimp termination ¹	•	•
Solder termination	•	•
PCB termination	•	•

¹ Crimp-clip-contacts available with diameter 0.7 mm, 0.9 mm, 1.3 mm and 1.6 mm

STANDARD PIN CONTACTS

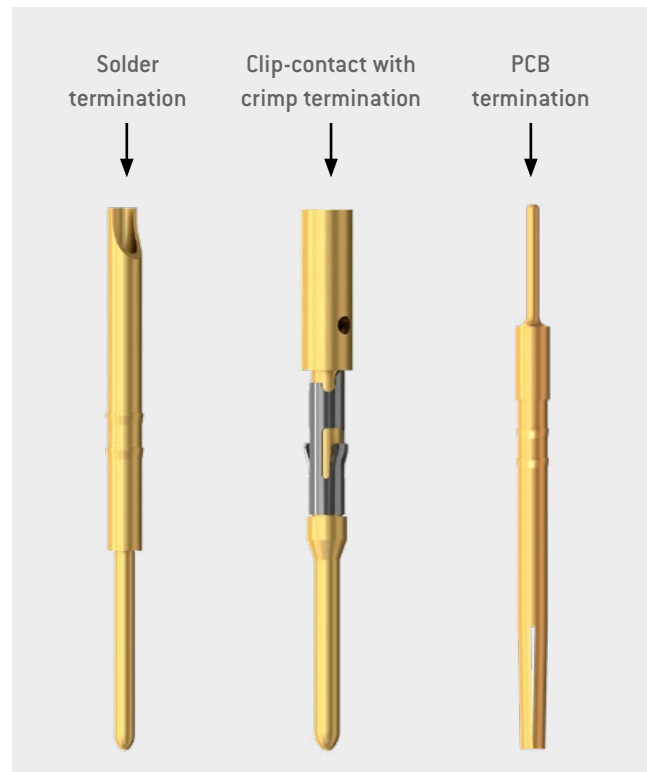

Information on diameters, terminal types and current-carrying capacity can be found after the insert section.



ODU MINI-SNAP®



CONFIGURATION

Step by step configuration process

STEP BY STEP TO THE PERFECT CONNECTION

ODU offers high-quality connectors and comprehensive service for complete assembly. From connectors to watertight potting, we provide the complete system from a single source.

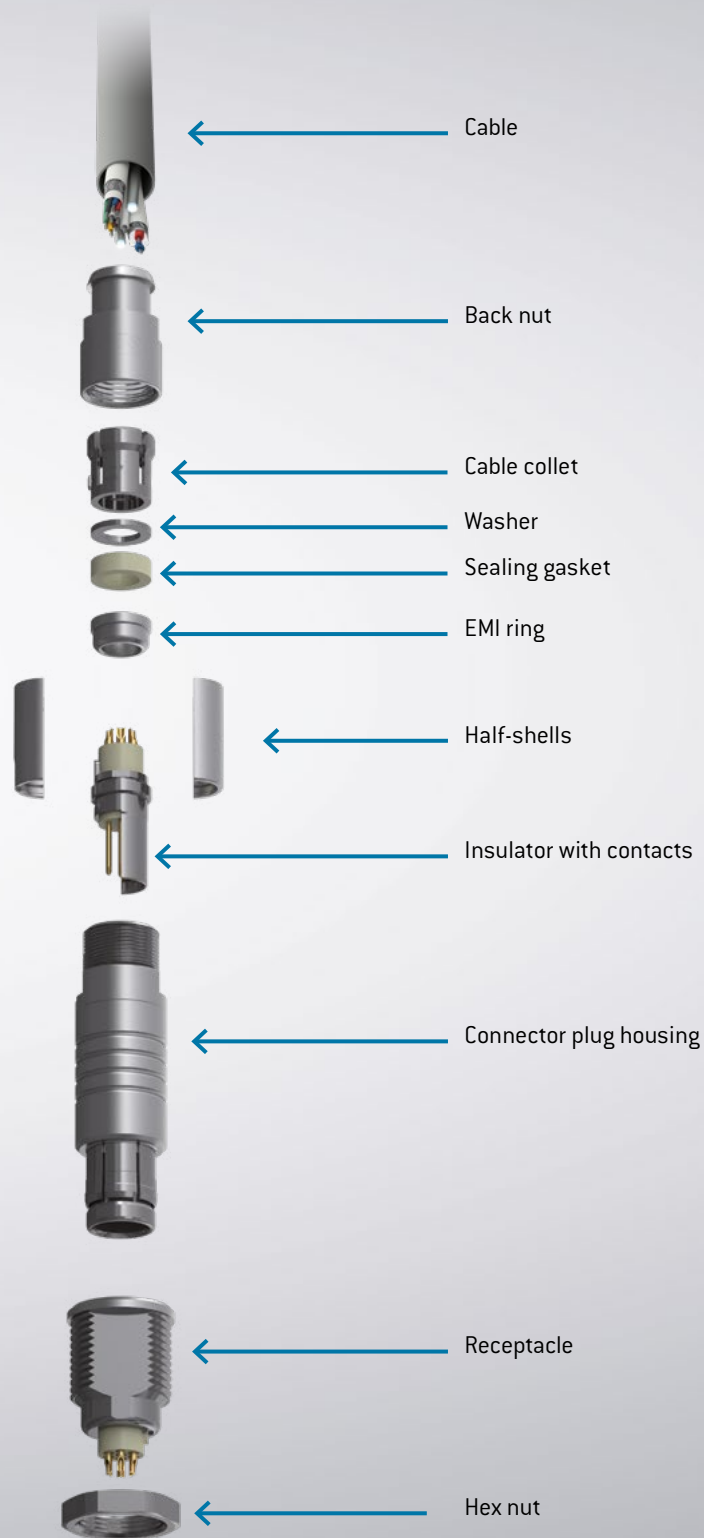

YOUR WAY TO AN INDIVIDUAL CONNECTION:

HOW TO CONFIGURE WITH THE CONNECTOR PART NUMBER KEY

This shows you how ODU's connector part number key is composed. In the first part of the configuration, select the connector plug housing (such as style and size) of the connector. In the middle part of the part number key, you can configure the contact insert and in the last part the cable entry.

Type

- A = Break-away connector / panel mounted plug
- G = Receptacle
- K = In-line receptacle
- S = Plug
- W = Right-angled plug

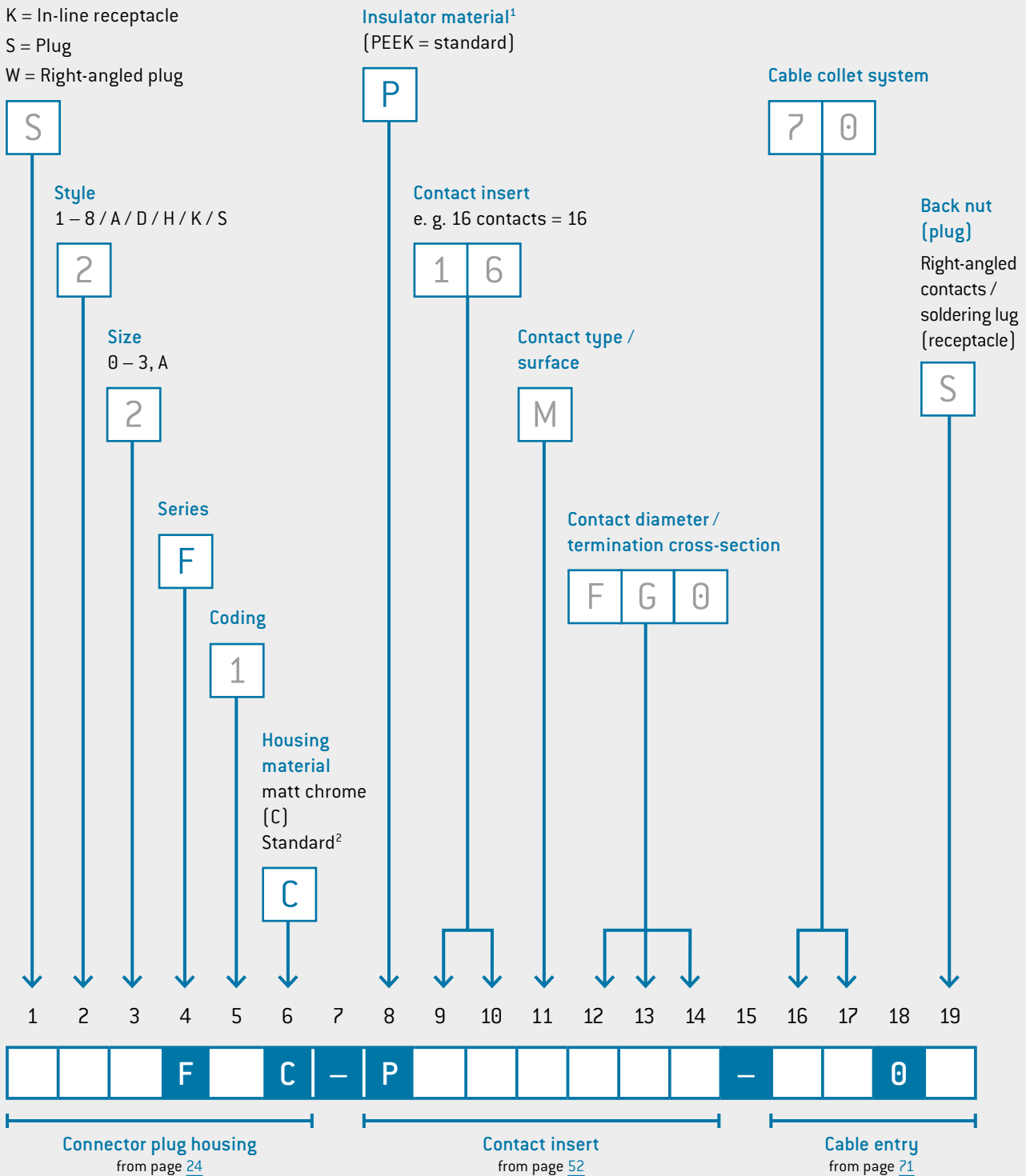

¹Other insulation materials on request. ²Tin-nickel plated on request.

SAMPLE CONFIGURATION STEP BY STEP

The perfect product in just a few steps. These step-by-step instructions show you how to configure your own individual product with the ODU part number key based on a sample configuration.



Connector in style 2 / size 2 / series F / coding 1 / connector plug housing Cu-alloy matt chrome plated / insulator PEEK / 16 contacts / pin (solder) / termination cross-section AWG22 / cable diameter 6.5 – 7 mm / back nut for silicone cable bend relief (silicone cable bend relief has to be ordered separately)

STEP 1: SERIES (SEE POSITION 4)

1	2	3	4	5	6	7	8	9	10	11	12	13	14	15	16	17	18	19
			F		C	-	P							-			0	

←  SERIES F

STEP 2: TYPE/STYLE (SEE POSITIONS 1, 2 AND 19)

PAGE 24

1	2	3	4	5	6	7	8	9	10	11	12	13	14	15	16	17	18	19
S	2		F		C	-	P							-			0	S

←  STYLE S 2 WITH BACK NUT FOR SILICONE CABLE BEND RELIEF

STEP 3: SIZE (SEE POSITION 3)

PAGE 24

1	2	3	4	5	6	7	8	9	10	11	12	13	14	15	16	17	18	19
S	2	2	F		C	-	P							-			0	S

←  SIZE 2

STEP 4: CODING (SEE POSITION 5)

PAGE 23

1	2	3	4	5	6	7	8	9	10	11	12	13	14	15	16	17	18	19
S	2	2	F	1	C	-	P							-			0	S

←  CODING 1

STEP 5: HOUSING MATERIAL (SEE POSITION 6)

PAGE 23

1	2	3	4	5	6	7	8	9	10	11	12	13	14	15	16	17	18	19
S	2	2	F	1	C	-	P							-			0	S

←  CR matt
SURFACE MATT CHROME (FURTHER ON REQUEST)

STEP 6: INSULATOR MATERIAL (SEE POSITION 8)

1	2	3	4	5	6	7	8	9	10	11	12	13	14	15	16	17	18	19
S	2	2	F	1	C	-	P							-			0	S

←  PEEK

STEP 7: CONTACT INSERT (SEE POSITIONS 9 AND 10) PAGE 52 – 68

1	2	3	4	5	6	7	8	9	10	11	12	13	14	15	16	17	18	19
S	2	2	F	1	C	-	P	1	6					-			0	S

←  16 CONTACTS

STEP 8: CONTACT TYPE / SURFACE (SEE POSITION 11)

1	2	3	4	5	6	7	8	9	10	11	12	13	14	15	16	17	18	19
S	2	2	F	1	C	-	P	1	6	M				-			0	S

←  SOLDER (PIN)

STEP 9: CONTACT DIAMETER (SEE POSITION 12)

1	2	3	4	5	6	7	8	9	10	11	12	13	14	15	16	17	18	19
S	2	2	F	1	C	-	P	1	6	M	F			-			0	S

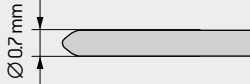
←  Ø 0.7 mm

STEP 10: TERMINATION CROSS-SECTION (SEE POSITIONS 13 AND 14)

1	2	3	4	5	6	7	8	9	10	11	12	13	14	15	16	17	18	19
S	2	2	F	1	C	-	P	1	6	M	F	G	0	-			0	S

←  AWG 22

STEP 11: CABLE COLLET SYSTEM (SEE POSITIONS 16 AND 17)

1	2	3	4	5	6	7	8	9	10	11	12	13	14	15	16	17	18	19
S	2	2	F	1	C	-	P	1	6	M	F	G	0	-	7	0	0	S

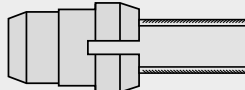
←  MAX. CABLE-Ø 7 mm
MIN. CABLE-Ø 6.5 mm

YOUR WAY TO AN INDIVIDUAL CABLE ASSEMBLY SOLUTION

HOW TO CONFIGURE WITH THE CABLE NUMBER KEY

This shows you how ODU's cable number key is composed. In the first part of the configuration – after the "C" for cable, please insert the first 6 positions of your connector number key.

In the middle part of the cable number key, you configure bend relief, color and count number.

The last 6 positions determine the length of the cable in mm.

Cable assembly

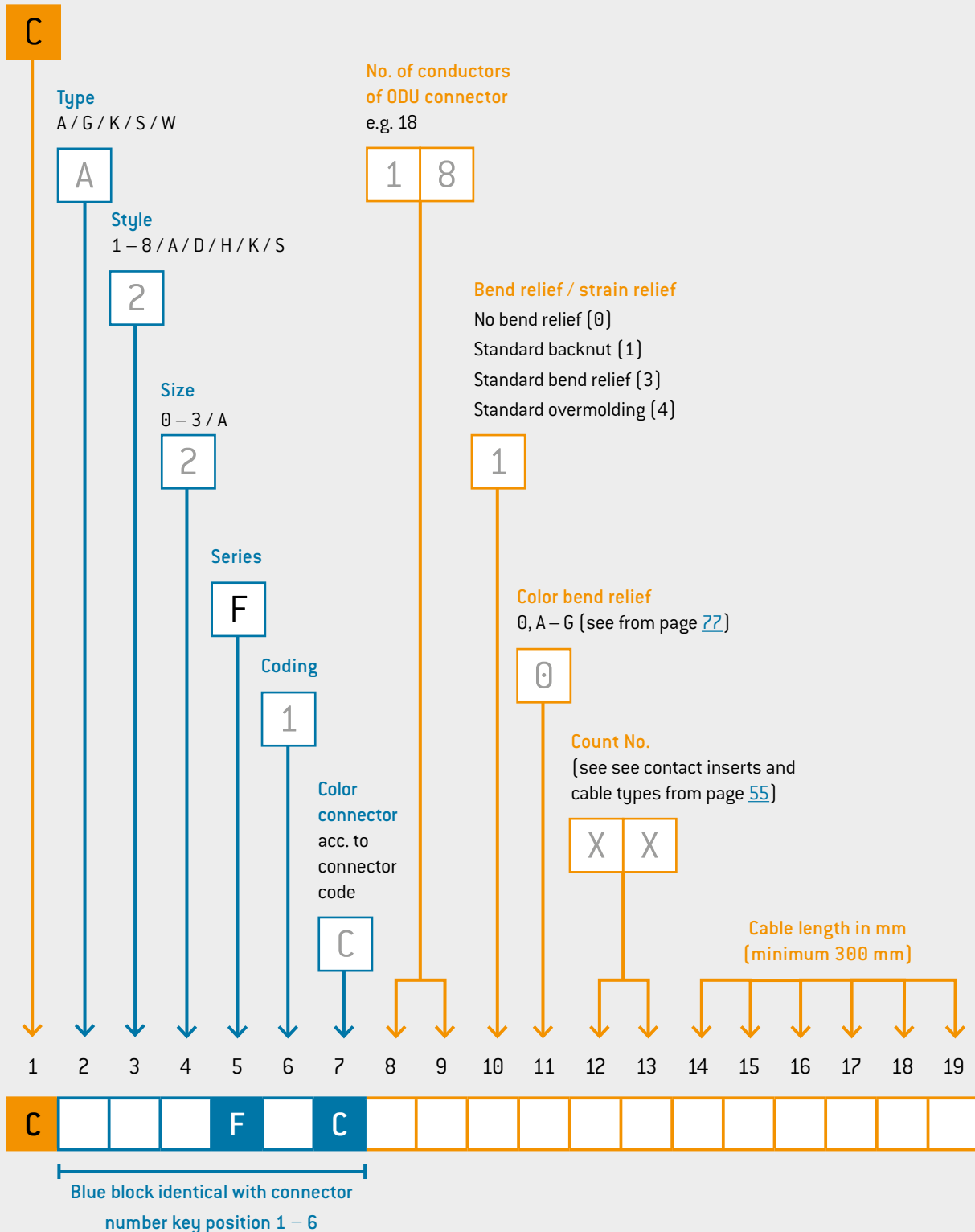

CABLE SPECIFICATIONS

TECHNICAL DATA



SINGLE WIRE PVC

UL-STYLE 1061 / 10002 | UL-STYLE 1007 / 1569 | UL-STYLE 1015

Conductor	TPC – tin plated copper acc. to EN13602:2013
Insulation	UL-PVC semi-rigid (UL-Style 1061 / 10002) UL-PVC 105 °C (UL-Style 1007 / 1569 & 1015)
Temperature range in motion	-10 up to +105 °C
Temperature range at rest	-30 up to +105 °C
Spark test	2,500 V (UL-Style 1061 / 10002) 3,000 V (UL-Style 1007 / 1569) 6,000 V (UL-Style 1015)
Operating voltage	300 V (UL-Style 1061 / 10002 & 1007 / 1569) 600 V (UL-Style 1015)



MULTI-CONDUCTOR CABLES PVC – UNSCREENED

UL / cUL – LIYY STYLE 2464 / 2517-10002

Conductor	TPC – tin plated copper acc. to EN13602:2013
Insulation	UL-PVC semi-rigid (core) UL-PVC 105 °C (jacket)
Temperature range in motion	-10 up to +80 °C (style 2464) -10 up to +105 °C (style 2517)
Temperature range at rest	-30 up to +80 °C (style 2464) -30 up to +105 °C (style 2517)
Spark test	1,500 V
Operating voltage UL	300 V



MULTI-CONDUCTOR CABLES PVC – SCREENED

UL / cUL – LIYCY STYLE 2464 / 2517-10002

Conductor	TPC – tin plated copper acc. to EN13602:2013
Insulation	UL-PVC semi-rigid (core) UL-PVC 105 °C (jacket)
Shielding	copper braid tinned
Temperature range in motion	-10 up to +80 °C (style 2464) -10 up to +105 °C (style 2517)
Temperature range at rest	-30 up to +80 °C (style 2464) -30 up to +105 °C (style 2517)
Spark test	1,500 V
Operating voltage UL	300 V

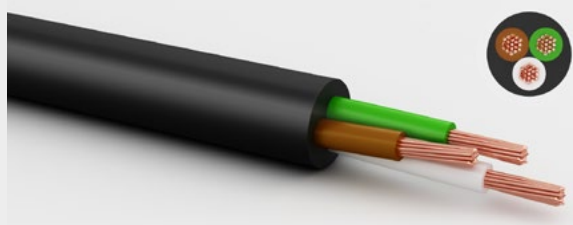

MULTI-CONDUCTOR CABLES, PUR – UNSCREENED

UL / cUL – STYLE 20233/10042

Conductor	bare copper acc. to EN13602:2013
Insulation	TPE (12Y) thermoplastic compound (core) PUR – {11Y} / UL-AWM758 (jacket)
Temperature range in motion	-40 up to +80 °C
Temperature range at rest	-50 up to +80 °C
Spark test	1,500 V
Operating voltage UL	300 V

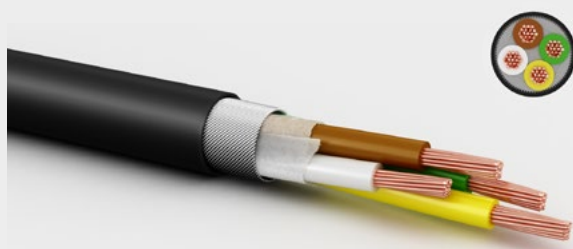

MULTI-CONDUCTOR CABLES PUR – SCREENED

D-UL / cUL – STYLE 20233/10042

Conductor	bare copper acc. to EN13602:2013
Insulation	TPE (12Y) thermoplastic compound (core) PUR – {11Y} / UL-AWM758 (jacket)
Shielding	spiral shield; tinned copper
Temperature range in motion	-40 up to +80 °C
Temperature range at rest	-50 up to +80 °C
Spark test	1,500 V
Operating voltage UL	300 V



ODU MINI-SNAP®

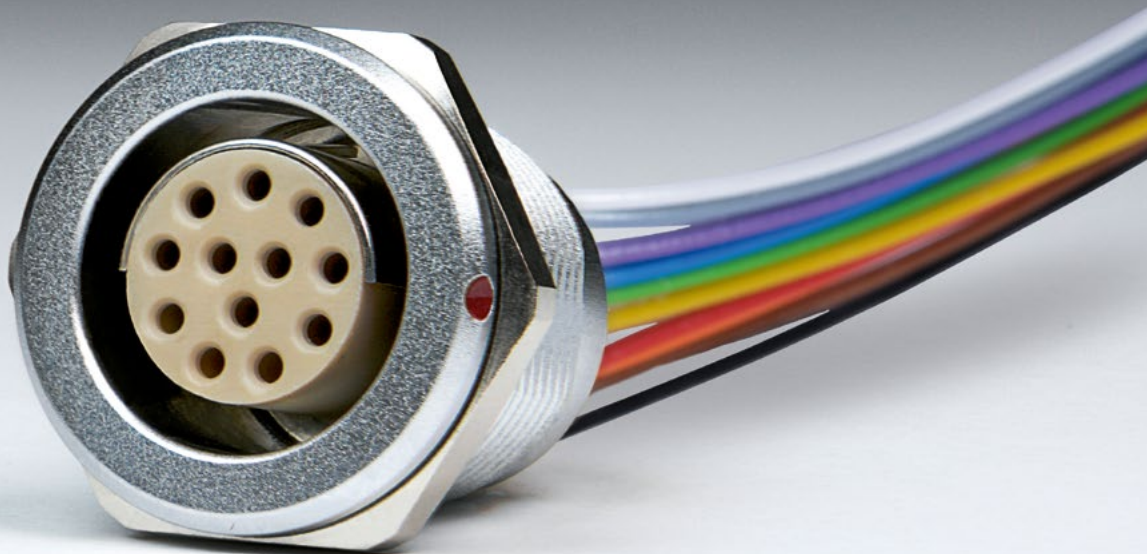

ODU MINI-SNAP® SERIES F

Summary ODU MINI-SNAP® Series F	20
Cross-sectional view of the connector	22
Codings	23
Plugs and cable assemblies	24
Receptacles and cable assemblies	40
Contact inserts, cable types and PCB layouts	52
Cable collet system	71
Accessories	72

SUMMARY ODU MINI-SNAP® SERIES F



The ODU MINI-SNAP® Series F with coding using a half-shell. These push-pull circular connectors and cable assemblies can be configured in many different ways: a wide variety of sizes and termination types and contact inserts are available.

- Coding over half-shell
- 2 to 27 contacts / mixed inserts
- Up to 5 sizes and 3 termination types
- Large selection of connectors, receptacles and cable assembly types to choose from
- Protection class IP50 and IP68 available
- 5,000 mating cycles and more
- Contacts for solder, crimp and PCB termination

STRAIGHT PLUG		P. 24
IP50		S 1
		S 2
IP68 ¹		S 3
		S 4

BREAK-AWAY CONNECTOR		P. 28
IP68 ¹		A 5
		A 6
IP50		A 7
		A 8







PANEL MOUNTED PLUG		P. 32
IP50		A A
IP68 ^{1,2}		A D





SUPER SHORTY PUSH-PULL PLUG		P. 34
IP68 ¹		S S
		A S

¹ In mated condition

² In unmated condition

RIGHT-ANGLED PLUG		P. 36
IP50		W 1
		W 2
IP68 ¹		W 3
		W 4

RECEPTACLE		P. 44
IP50		G 1
IP68 ²		G 2
		G 4
IP50		G 5
IP68 ²		G 8
IP50		G H
		G K

IN-LINE RECEPTACLE		P. 40
IP50		K 1
		K 2
IP68 ¹		K 3
		K 4

For assembly instructions please refer to our website: odu-connectors.com/downloads

¹ In mated condition
² In unmated condition

CROSS-SECTIONAL VIEW OF THE CONNECTOR

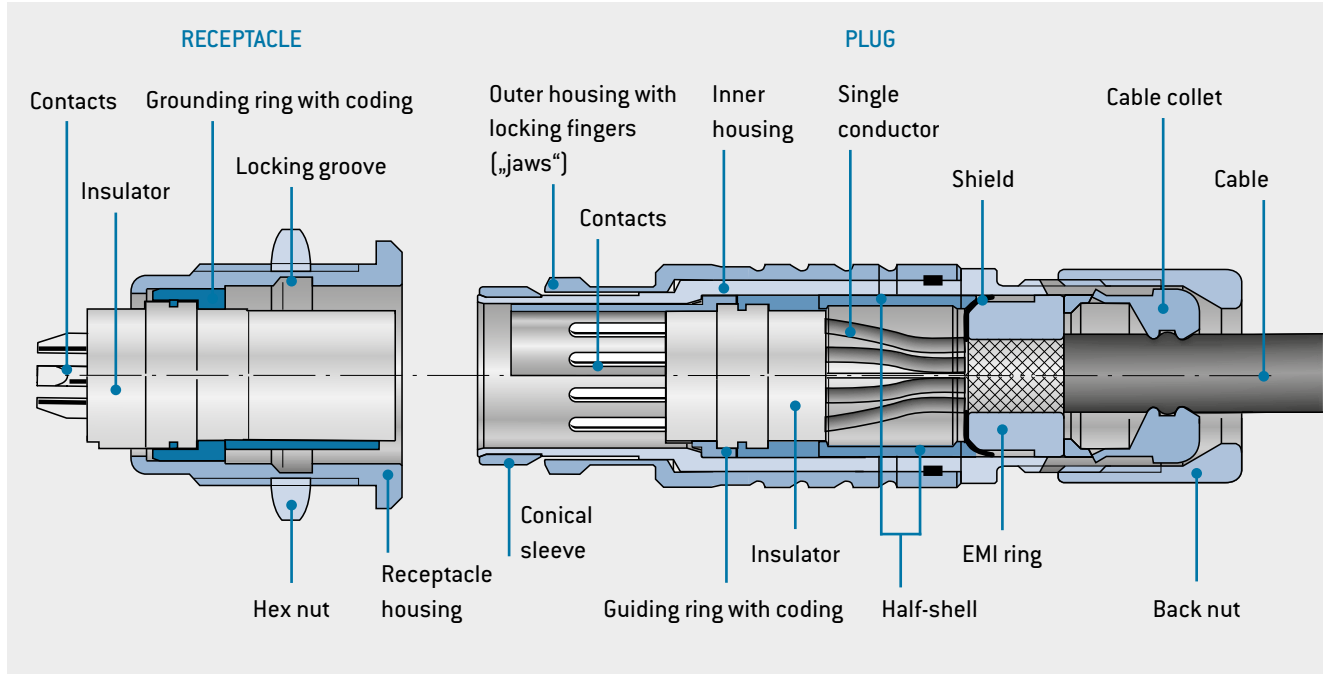

AVAILABLE SIZES

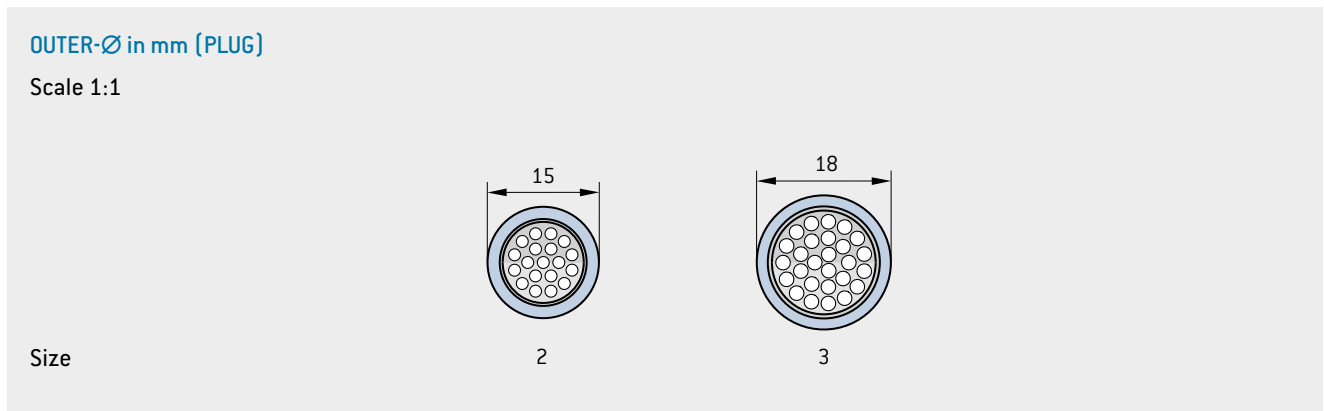
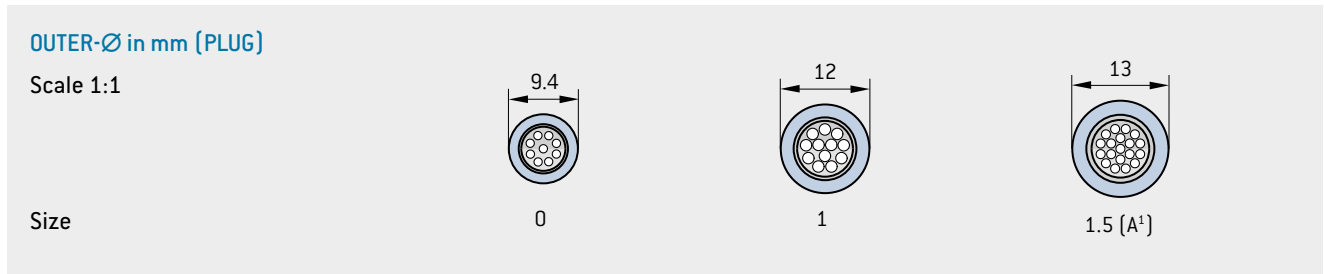

¹ Configuration in part number key for size 1.5

CODINGS

	Receptacle mating side	Plug mating side	Size				
			0	1	1.5	2	3
1			●	●	●	●	●
2			●	●			
					●	●	●
3			○				
				○			
					○	○	○

Housing material – surface	
C	Standard Cu alloy / matt chrome plated
Z	On request Cu alloy / tin-nickel plated

Special materials and surfaces on request.

2 3 4 5 6 7 8 9 10

F C - P

● Standard
○ On request

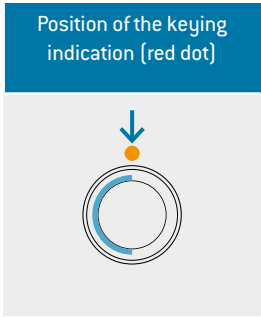

1 2 3 4 5 6 7 8 9 10 11 12 13 14 15 16 17 18 19

F C - P - 0

STRAIGHT PLUG

S 1 0 **STYLE: 1** With standard back nut IP50

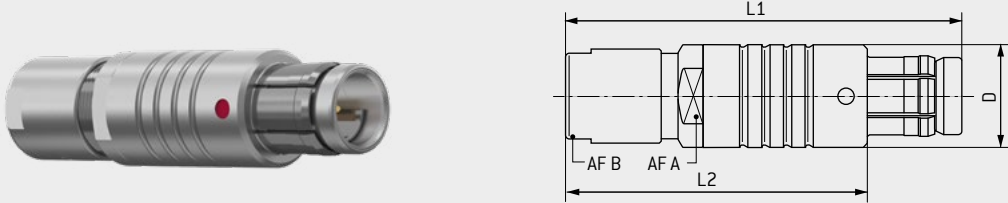

S 2 S **STYLE: 2** With back nut for cable bend relief¹ IP50

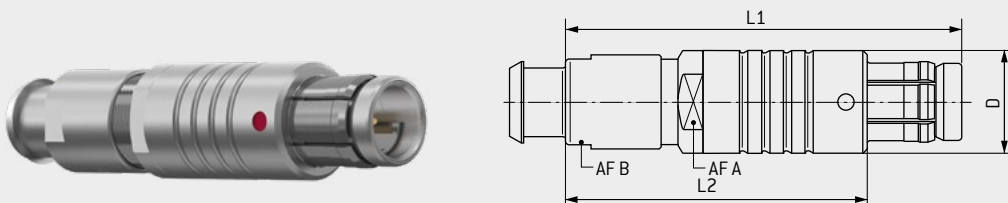

Size	L1 mm	L2 mm	D mm	AFA mm	S1 AF B mm	S2 AF B mm
0	≈ 37	≈ 27	9.4	8	7	7
1	≈ 46	≈ 35	12	10	10	10
A	≈ 48	≈ 38	13	11	12	12
2	≈ 50	≈ 38	15	13	12	13
3	≈ 59	≈ 44	18	16	15	15

TECHNICAL DATA

- Contact inserts from page 52

0 1 A 2 3

1 2 3 4 5 6 7 8 9 10 11 12 13 14 15 16 17 18 19

F C - P - 0

¹ Please order cable bend reliefs separately, see page 77.

For support and customer specific solutions: sales@odu.de

CABLE ASSEMBLY – STRAIGHT PLUG

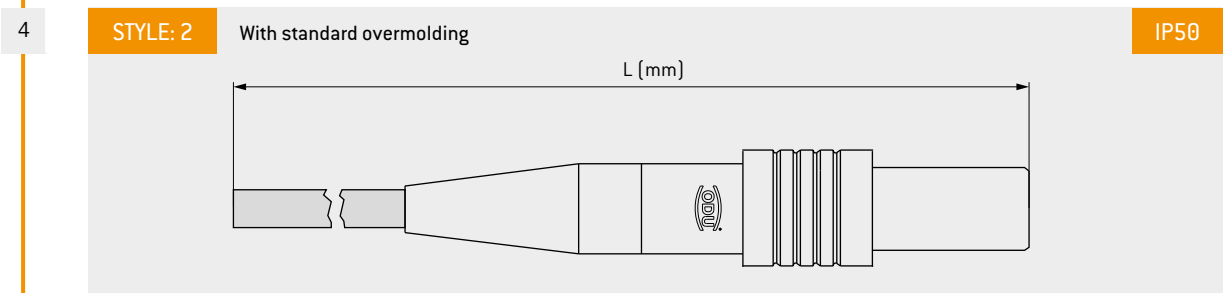
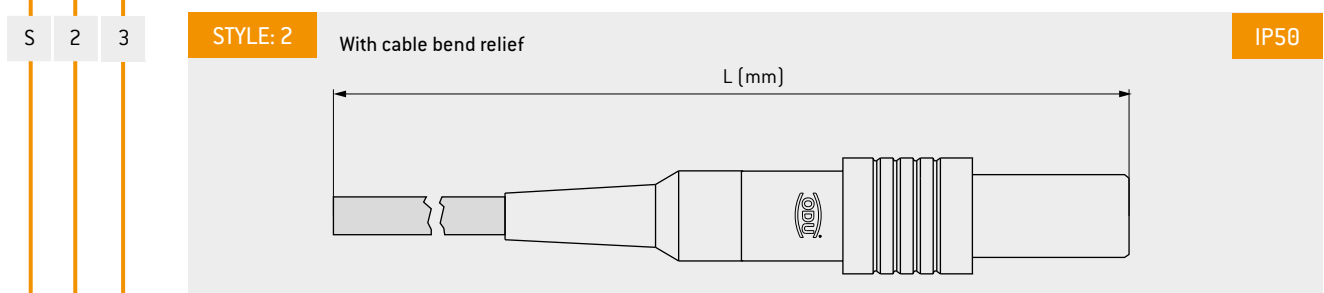
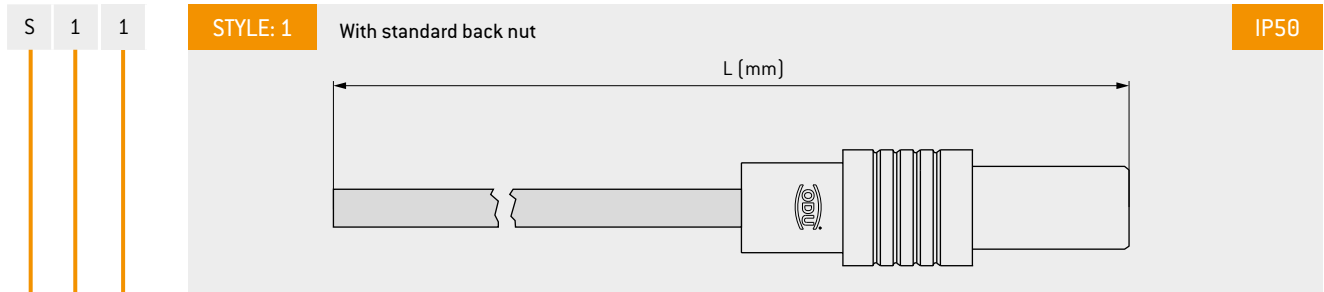

TECHNICAL DATA

- Contact inserts and cable types from page 52

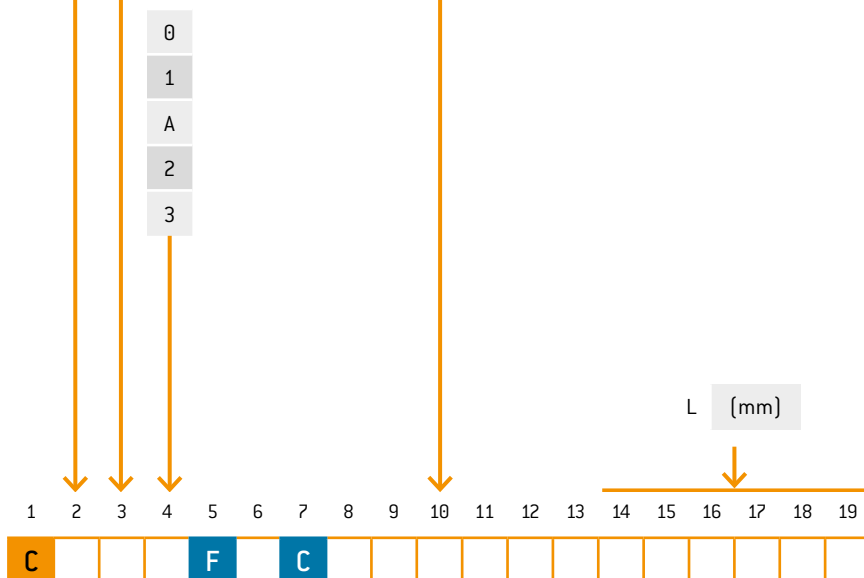

For support and customer specific solutions: sales@odu.de

STRAIGHT PLUG

S 3 0 **STYLE: 3** With standard back nut IP68

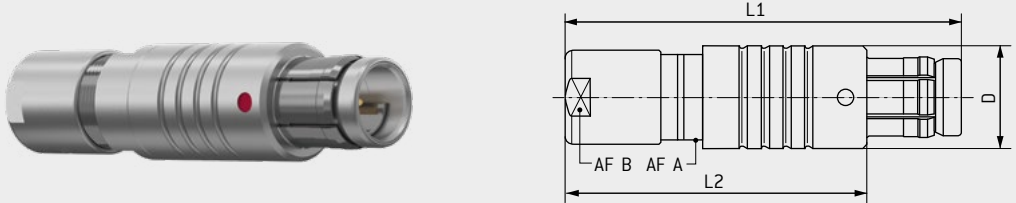

S 4 S **STYLE: 4** With back nut for cable bend relief¹ IP68

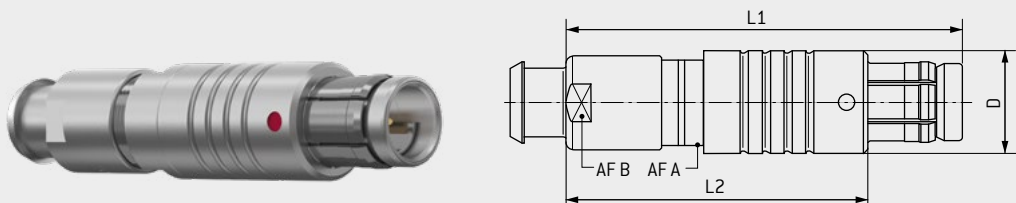

Size	L1 mm	L2 mm	D mm	AFA mm	S3 AF B mm	S4 AF B mm
0	≈ 40	≈ 30	9.4	8	7	7
1	≈ 49	≈ 38	12	10	10	10
A	≈ 50	≈ 40	13	11	12	12
2	≈ 53	≈ 41	15	13	12	13
3	≈ 61	≈ 46	18	16	15	15

TECHNICAL DATA

- Contact inserts from page 52
- IP68 in mated condition

0 1 A 2 3

1 2 3 4 5 6 7 8 9 10 11 12 13 14 15 16 17 18 19

F C - P - 0

¹ Please order cable bend reliefs separately, see page 27.

CABLE ASSEMBLY – STRAIGHT PLUG

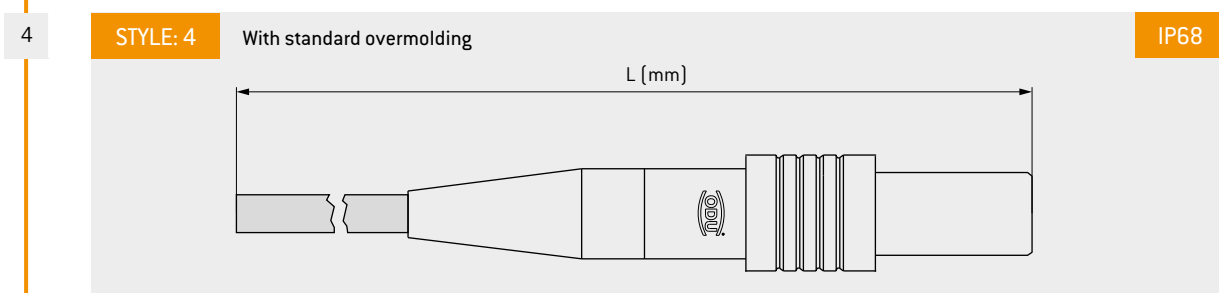
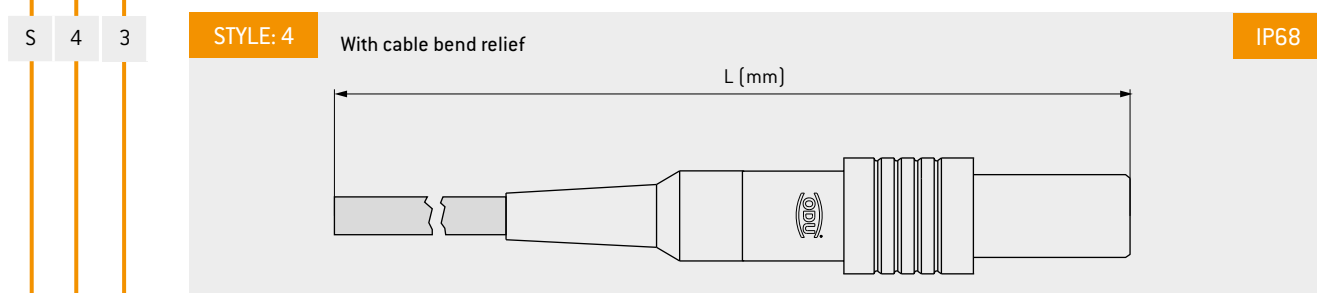
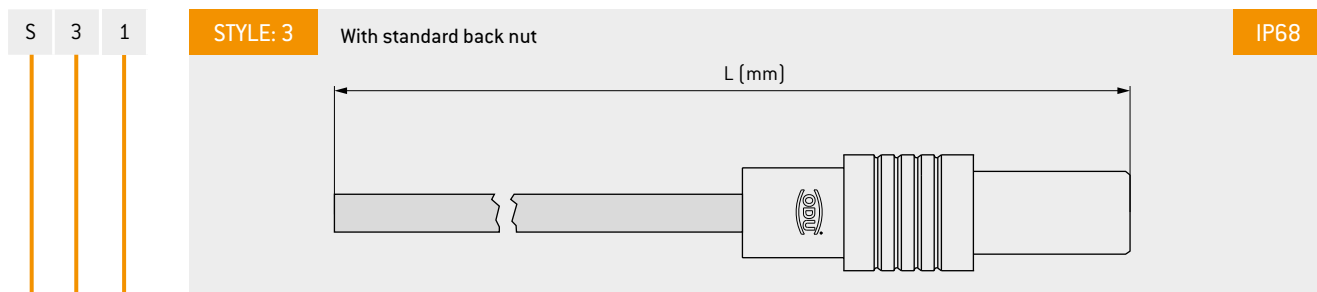

TECHNICAL DATA

- Contact inserts and cable types from page 52
- IP68 in mated condition

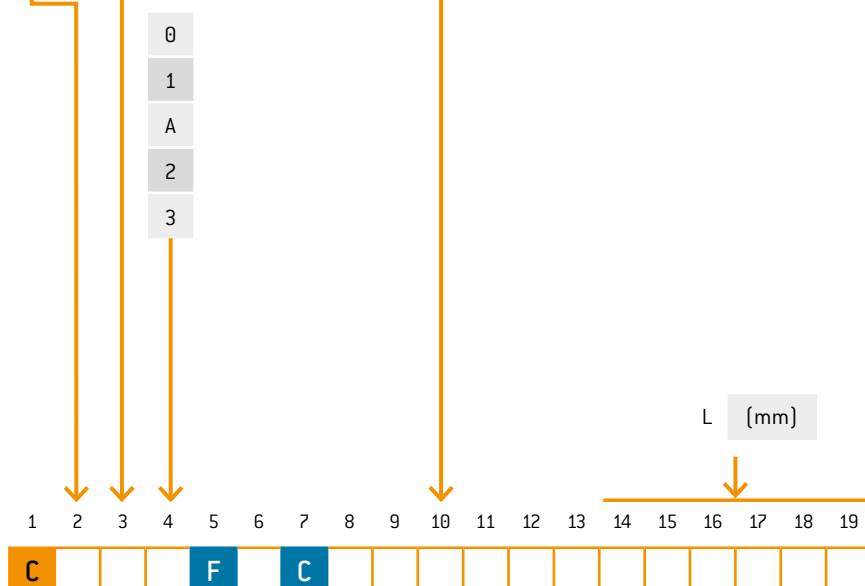

BREAK-AWAY CONNECTOR (WITHOUT LOCKING)

A 5 0 **STYLE: 5** With standard back nut **IP68**

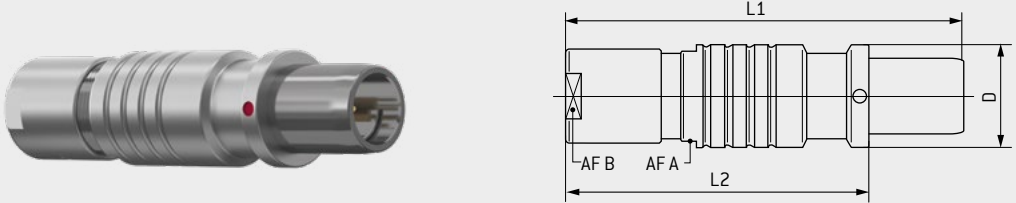

A 6 S **STYLE: 6** With back nut for cable bend relief¹ **IP68**

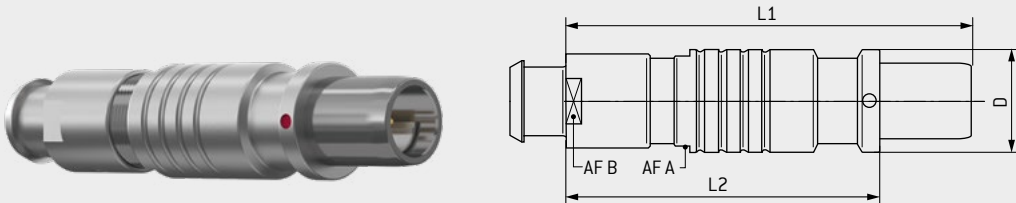

Size	L1 mm	L2 mm	D mm	AFA mm	A5 AF B mm	A6 AF B mm
1	≈ 49	≈ 38	12	10	10	10
1.5	≈ 50	≈ 40	13	11	12	12
3	≈ 61	≈ 46	18	16	15	15

TECHNICAL DATA

- Contact inserts from page 52
- Plug can be separated by pulling on the cable
- IP68 in mated condition

1
A
3

1 2 3 4 5 6 7 8 9 10 11 12 13 14 15 16 17 18 19

F C - P - 0

¹ Please order cable bend reliefs separately, see page 27.

CABLE ASSEMBLY – BREAK-AWAY CONNECTOR (WITHOUT LOCKING)

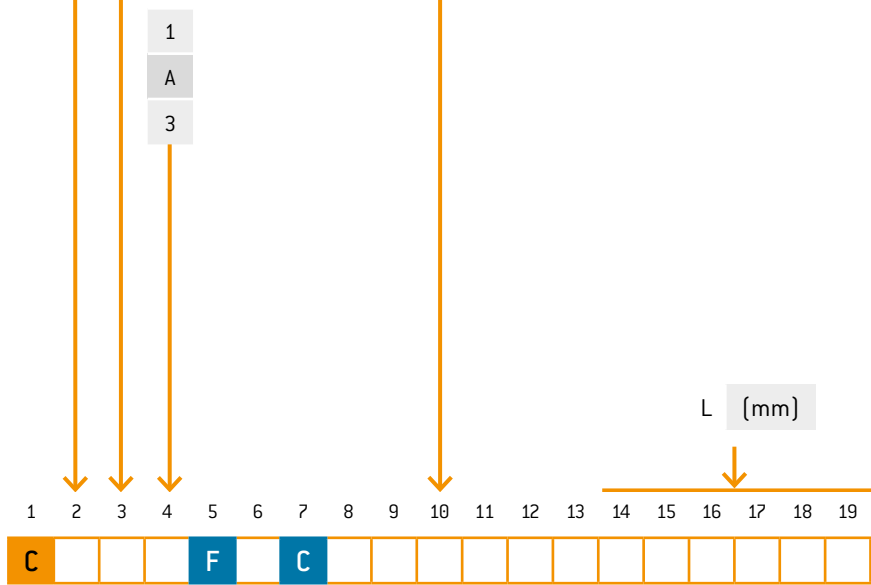
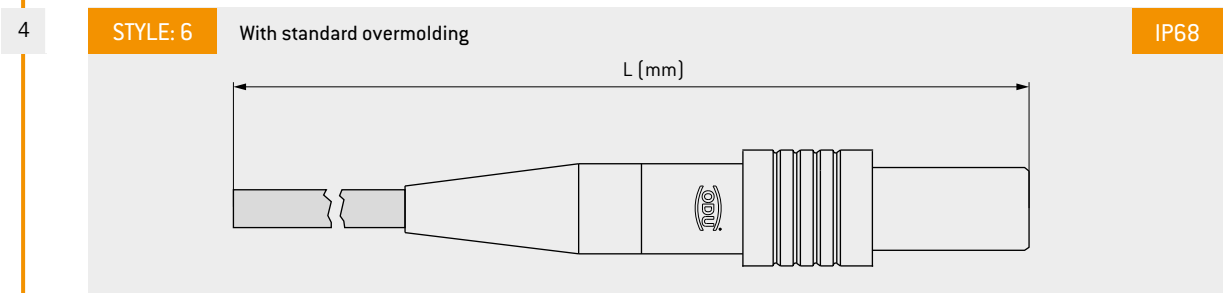
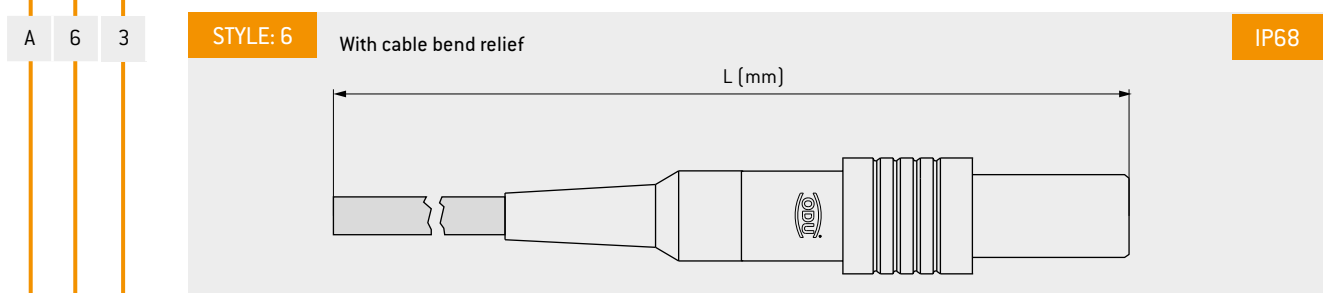
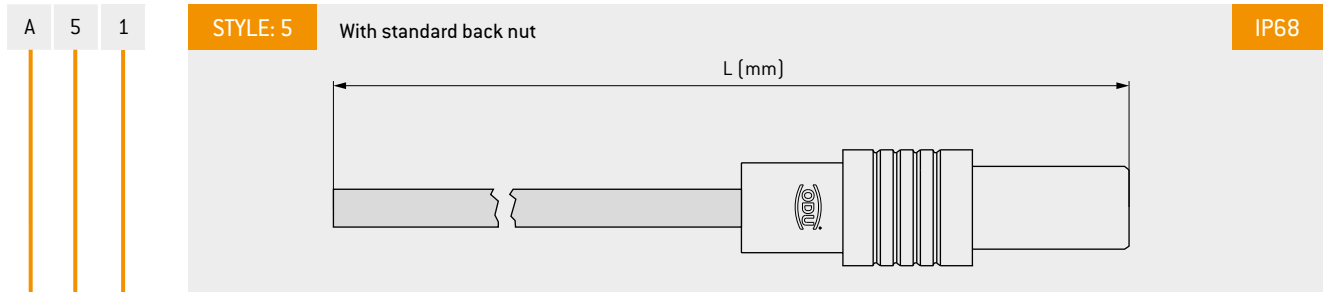

TECHNICAL DATA

- Contact inserts and cable types from page 52
- Plug can be separated by pulling on the cable
- IP68 in mated condition

BREAK-AWAY CONNECTOR (WITHOUT LOCKING)

A 7 0 **STYLE: 7** With standard back nut **IP50**

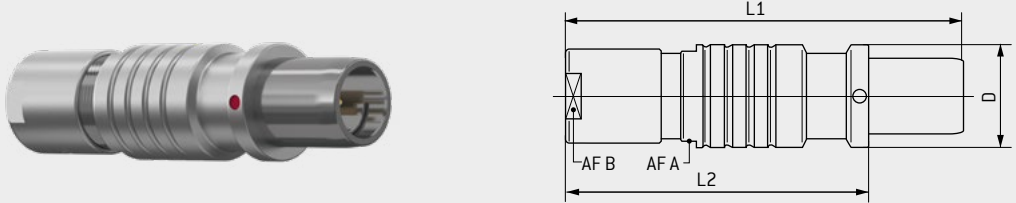

A 8 S **STYLE: 8** With back nut for cable bend relief¹ **IP50**

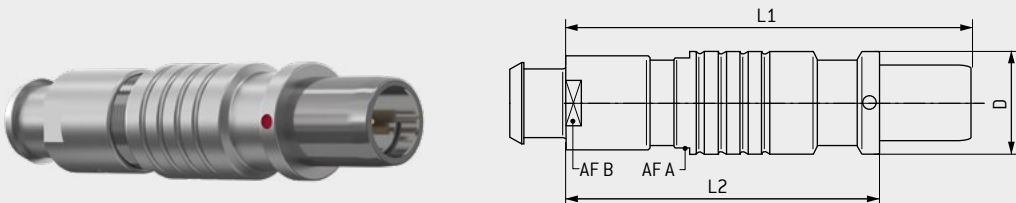

Size	L1 mm	L2 mm	D mm	AFA mm	A7 AF B mm	A8 AF B mm
0	≈ 37	≈ 27	9.4	8	7	7
1	≈ 46	≈ 35	12	10	10	10
2	≈ 50	≈ 38	15	13	12	13

TECHNICAL DATA

- Contact inserts from page 52
- Plug can be separated by pulling on the cable
- IP68 in mated condition

0 1 2

1 2 3 4 5 6 7 8 9 10 11 12 13 14 15 16 17 18 19

F C - P - 0

¹ Please order cable bend reliefs separately, see page 27.

CABLE ASSEMBLY – BREAK-AWAY CONNECTOR (WITHOUT LOCKING)

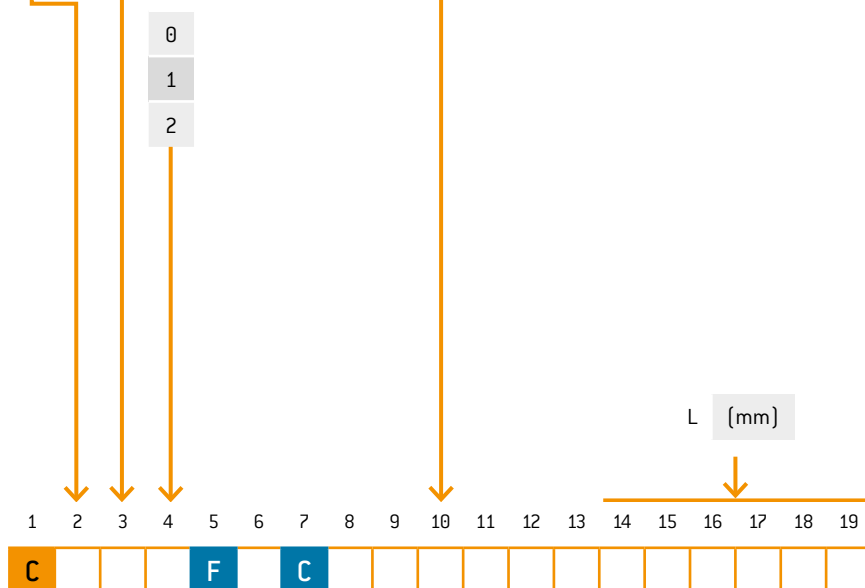
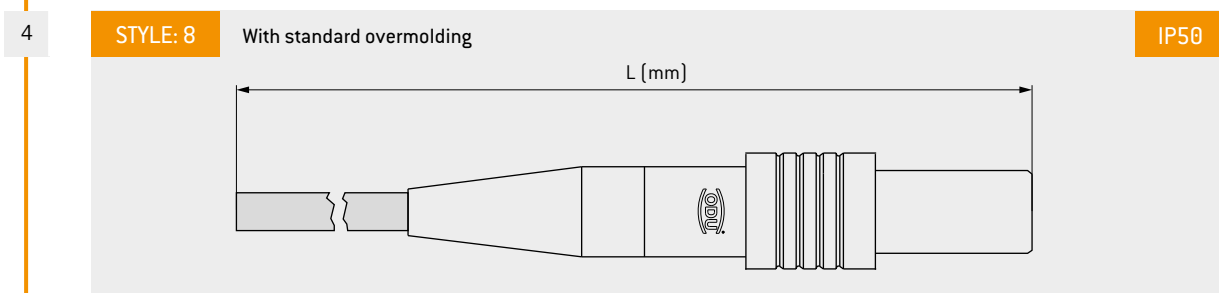
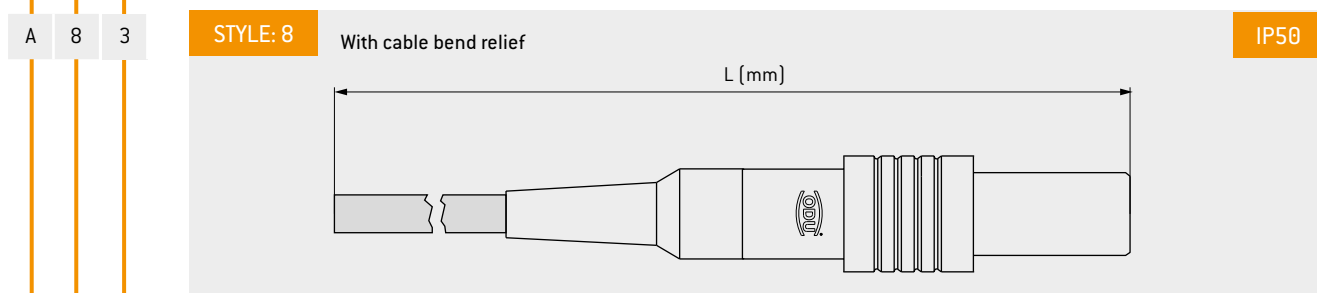
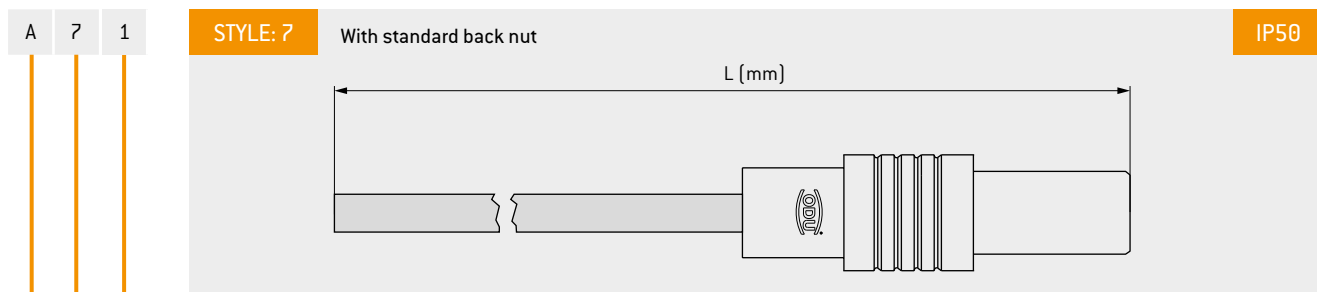

TECHNICAL DATA

- Contact inserts and cable types from page 52
- Plug can be separated by pulling on the cable
- IP68 in mated condition

PANEL MOUNTED PLUG

Suitable for creating a docking connection between 2 devices (e. g. on a charging station)

A A

STYLE: A

IP50

With hex nut, without locking, installation from front of panel

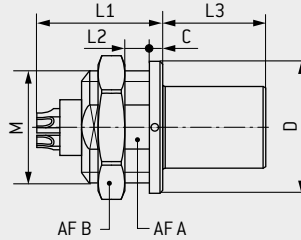

Panel cut-out

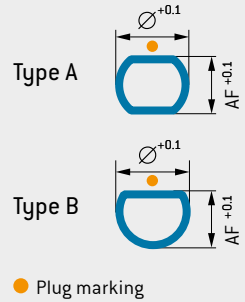

Size	L1 mm	L2 max. mm	L3 mm	C mm	D mm	AFA mm	AF B mm	M mm	Panel cut-out			
									AF mm	Ø mm	Type	
0	0	≈ 12	≈ 4	10	1.5	10	8.2	11	9 × 0.5	8.3	9.1	A
1	1	≈ 15.5	≈ 4	10.8	1.5	14	11.1	14	12 × 1	11.2	12.1	B
2	2	≈ 17.5	≈ 3.4	12	2	18	14.1	17	15 × 1	14.2	15.1	B
3 ¹	3 ¹	≈ 17	≈ 5.5	15	1.2	22	15.2	19	16 × 1	15.3	16.1	B

TECHNICAL DATA

- Contact inserts from page 52
- PCB layouts see from page 53
- IP50 in reference to the tightness of the end device
- Anti-rotation feature

A D

STYLE: D

IP68

With hex nut, without locking, installation from front of panel

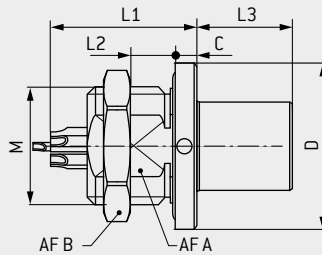

Panel cut-out

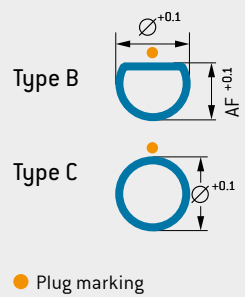

Size	L1 mm	L2 max. mm	L3 mm	C mm	D mm	AFA mm	AF B mm	M mm	Panel cut-out			
									AF mm	Ø mm	Type	
0	0	≈ 14.5	≈ 4.5	10	3	13	–	11	9 × 0.5	–	9.1	C
1 ¹	1 ¹	≈ 18.5	≈ 6.5	10.8	2.5	17	11	14	12 × 1	11.1	12.1	B
2 ¹	2 ¹	≈ 20	≈ 7	12	3	22	15.2	19	16 × 1	15.3	16.1	B

TECHNICAL DATA

- Contact inserts from page 52
- PCB layouts see from page 53
- IP68 in mated and unmated condition
- Anti-rotation feature (except size 0)
- No crimp contacts possible

1 2 3 4 5 6 7 8 9 10 11 12 13 14 15 16 17 18 19

F C - P - 0 0

¹ On request

CABLE ASSEMBLY – PANEL MOUNTED PLUG

A	A	0	0	STYLE: A	With hex nut, without locking, installation from front of panel	IP50
		1				
		2				
		3 ¹				

TECHNICAL DATA

- Contact inserts and cable types from page 52
- IP50 in reference to the tightness of the end device
- Anti-rotation feature (except size 0)

A	D	0	0	STYLE: D	With hex nut, without locking, installation from front of panel	IP68
		1 ¹				
		2 ¹				

TECHNICAL DATA

- Contact inserts and cable types from page 52
- IP68 in mated and unmated condition
- Anti-rotation feature (except size 0)
- No crimp contacts possible

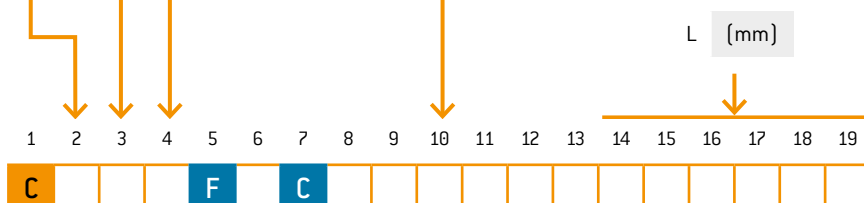

¹ On request

SUPER SHORTY PUSH-PULL PLUG

S S

STYLE: S

IP68

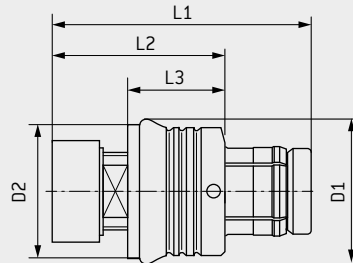

Conf. no.	for max. cable Ø	
0	5	5
1	7	0
A	8	8
2	0	2
3	1	2

Size	L1 mm	L2 mm	L3 mm	D1 mm	D2 mm	Max. cable Ø mm
0	≈ 28	≈ 18	10.5	13	11.9	5
1	≈ 32.7	≈ 22	12.5	15	13.9	6.5
1.5	≈ 32.5	≈ 23	13	15.7	14.5	8.3
2	≈ 34.3	≈ 22.6	13	19	17.6	10
3	≈ 38.4	≈ 23.3	13.8	23.9	21.9	11.5

TECHNICAL DATA

- Contact inserts from page 52
- Suitable for solder contacts only
- Crimping of the cable shield causes strain relief
- Suitable for overmolded shield crimping
- IP68 in mated condition [overmolded]

A S

STYLE: S Without locking

IP68

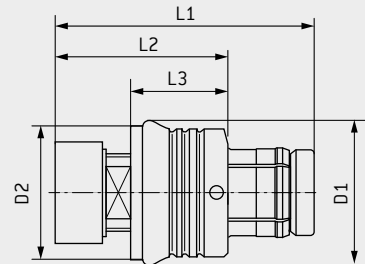

0 ¹	5	5
1 ¹	7	0
2 ¹	0	2

Size	L1 mm	L2 mm	L3 mm	D1 mm	D2 mm	Max. cable Ø mm
0 ¹	≈ 28	≈ 18	10.5	13	11.9	5
1 ¹	≈ 32.7	≈ 22	12.5	15	13.9	6.5
2 ¹	≈ 34.3	≈ 22.6	13	19	17.6	10

TECHNICAL DATA

- Contact inserts from page 52
- Suitable for solder contacts only
- Crimping of the cable shield causes strain relief
- Suitable for overmolded shield crimping
- IP68 in mated condition [overmolded]

1 2 3 4 5 6 7 8 9 10 11 12 13 14 15 16 17 18 19
 F C - P - 0 C

¹ On request

For support and customer specific solutions: sales@odu.de

CABLE ASSEMBLY – SUPER SHORTY PUSH-PULL PLUG

S	S	0	4	STYLE: S With standard overmolding	IP68
		1			
		A			
		2			
		3			

TECHNICAL DATA

- Contact inserts and cable types from page 52
- IP68 in mated condition [overmolded]

A	S	0 ¹	4	STYLE: S With standard overmolding, without locking	IP68
		1 ¹			
		2 ¹			

TECHNICAL DATA

- Contact inserts and cable types from page 52
- IP68 in mated condition [overmolded]

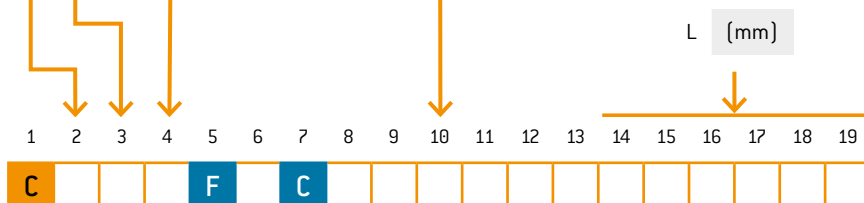

¹ On request

For support and customer specific solutions: sales@odu.de

RIGHT-ANGLED PLUG

W 1 0 **STYLE: 1** With standard back nut IP50

W 2 S **STYLE: 2** With back nut for cable bend relief¹ IP50

Size	L1 mm	L2 mm	L3 mm	C mm	D mm	AFA mm	W1 AF B mm	W2 AF B mm	AFC mm
0	33	23	≈ 25	10	9	9	7	7	8
1	37.3	26.5	≈ 28	12	11	11	10	10	10
A	39	29	≈ 31	14	13	12	12	12	11
2	41.6	29.5	≈ 34.5	16	14	14	12	13	13
3	50	35	≈ 41	18	17	16	15	15	16

TECHNICAL DATA

- Contact inserts from page 52

1 2 3 4 5 6 7 8 9 10 11 12 13 14 15 16 17 18 19

F C - P - 0

¹ Please order cable bend reliefs separately, see page 27.

CABLE ASSEMBLY – RIGHT-ANGLED PLUG

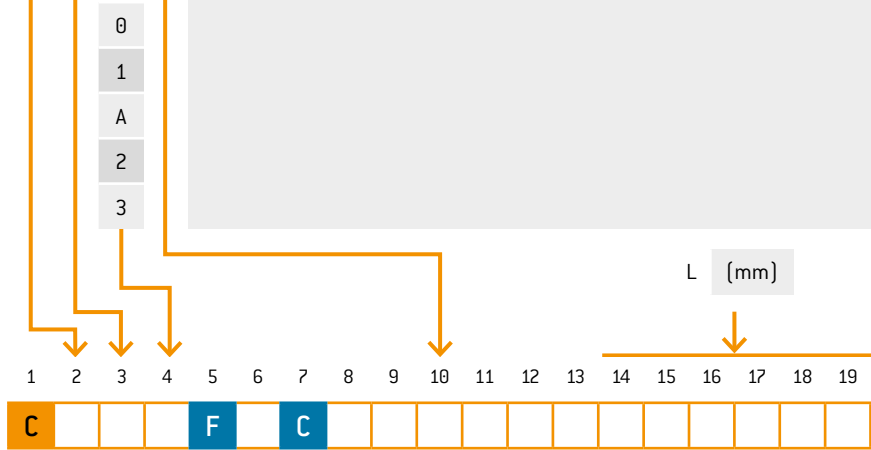
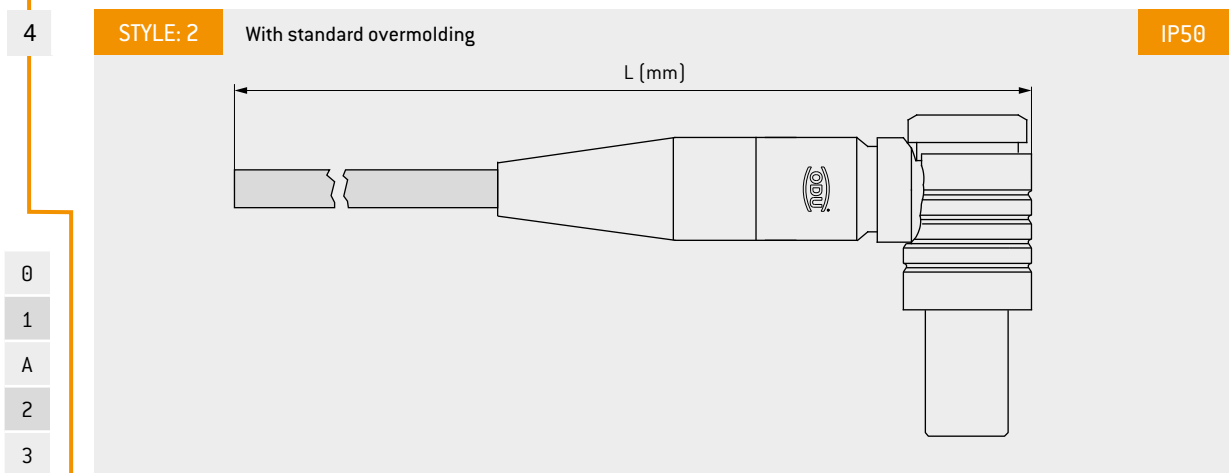
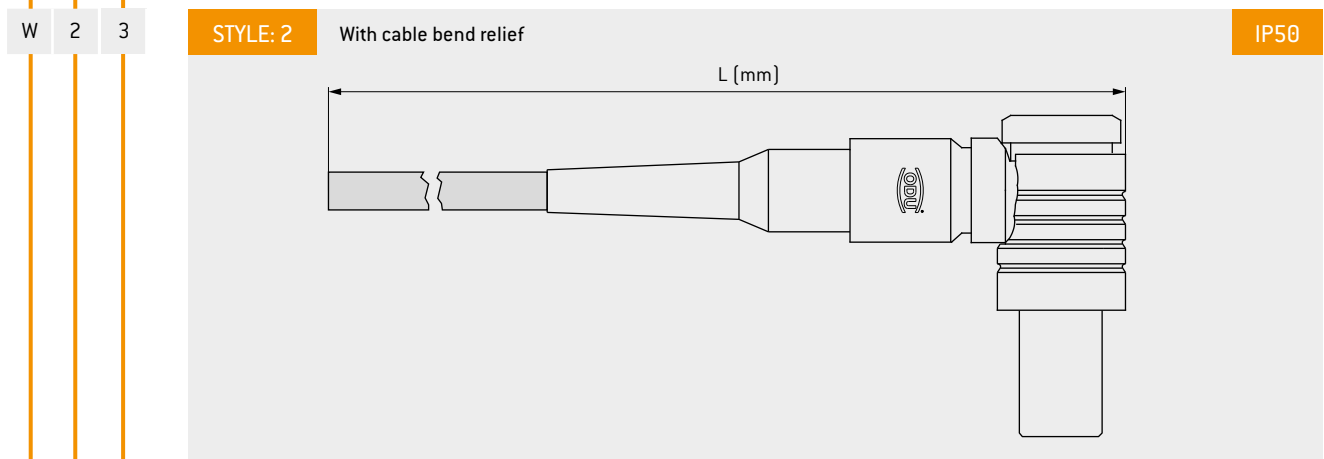
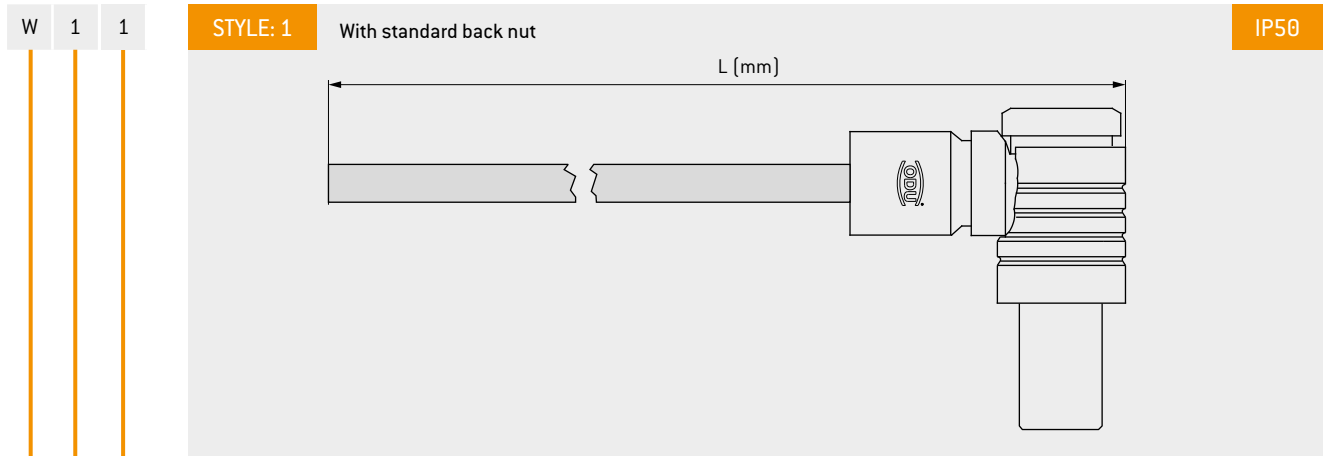

TECHNICAL DATA

- Contact inserts and cable types from page 52

RIGHT-ANGLED PLUG

W 3 0 **STYLE: 3** With standard back nut IP68

W 4 S **STYLE: 4** With back nut for cable bend relief¹ IP68

Size	L1 mm	L2 mm	L3 mm	C mm	D mm	AFA mm	W3 AF B mm	W4 AF B mm	AF C mm
0 ²	36	26	≈ 27	11.2	9	10	7	7	8
1 ²	45.2	34.2	≈ 33	13	11	12	10	10	10
A ²	1.5	41.5	≈ 34.5	14.5	13	13	12	12	11
2 ²	2	46.3	≈ 36	16	14	14	12	13	13
3 ²	3	59.7	≈ 41	18	17	16	15	15	16

TECHNICAL DATA

- Contact inserts from page 52
- IP68 in mated condition

1 2 3 4 5 6 7 8 9 10 11 12 13 14 15 16 17 18 19

F C - P - 0

¹ Please order cable bend reliefs separately, see page 27. ² On request

CABLE ASSEMBLY – RIGHT-ANGLED PLUG

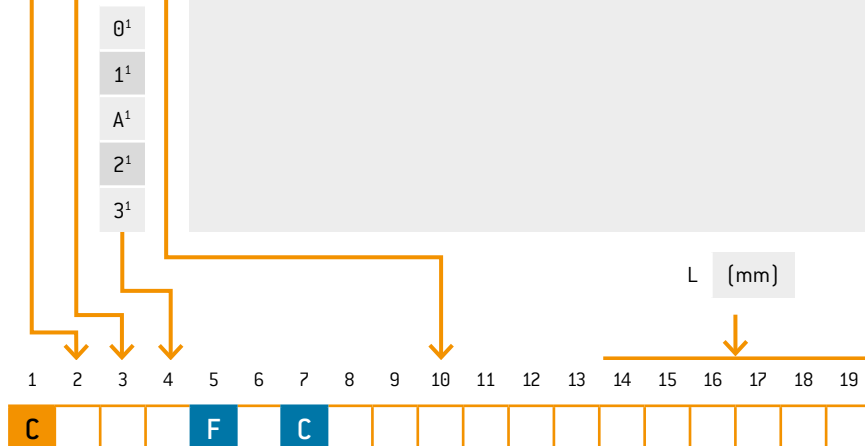
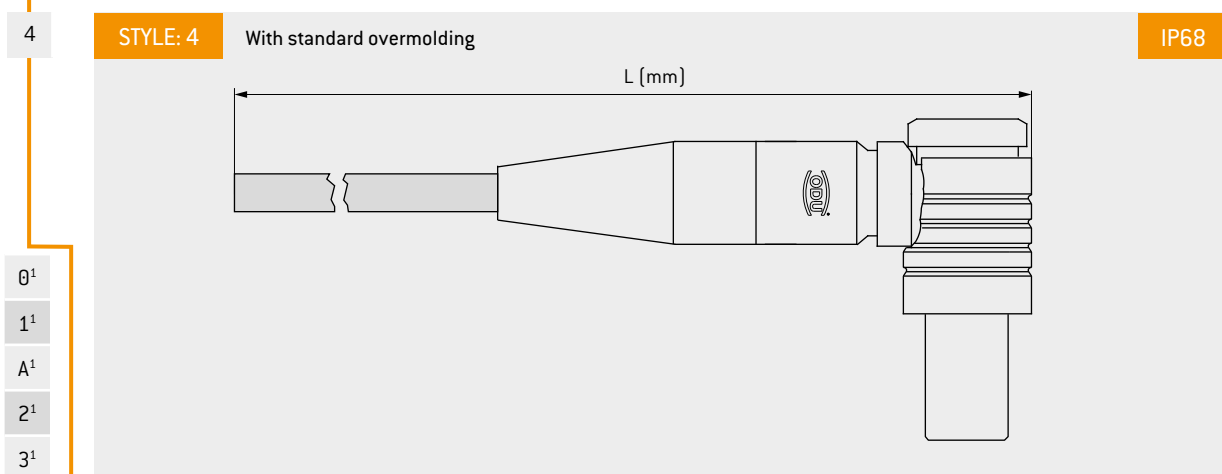
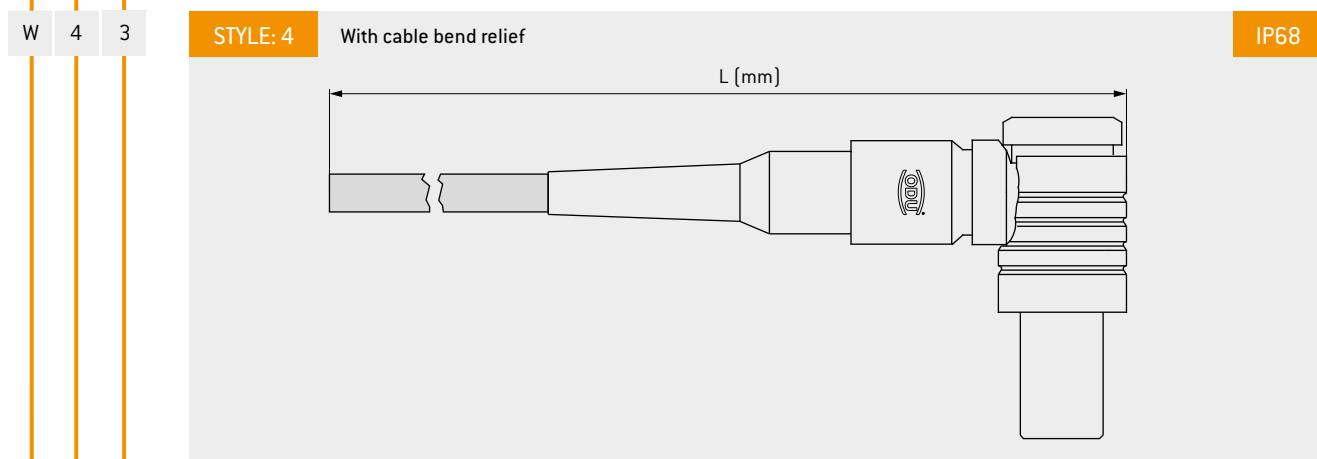
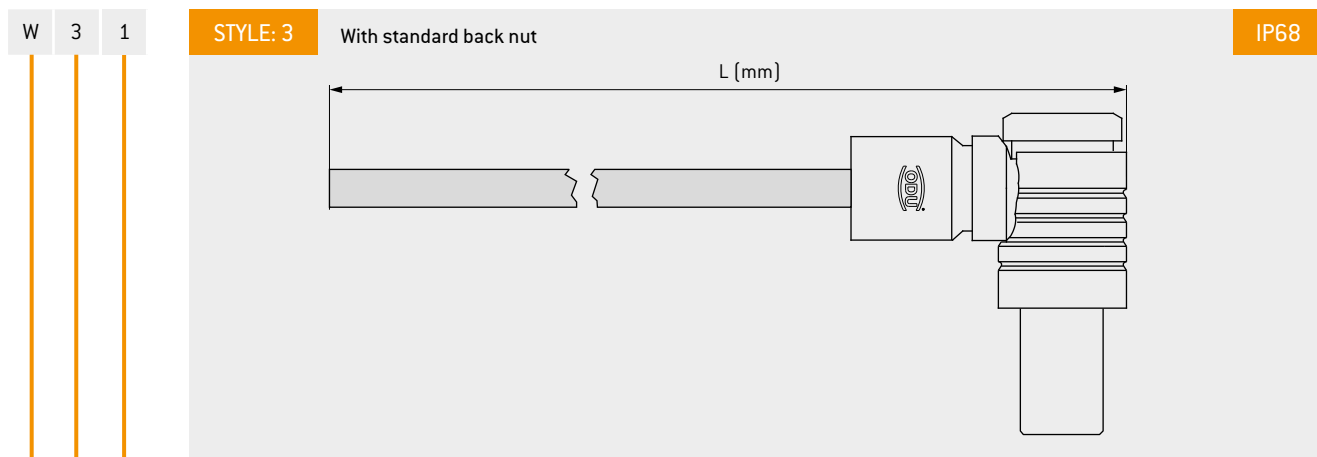

TECHNICAL DATA

- Contact inserts and cable types from page 52
- IP68 in mated condition

¹ On request

IN-LINE RECEPTACLE

Suitable for creating a cable-cable or cable-docking connection.

K 1 0 **STYLE: 1** With standard back nut **IP50**

K 2 S **STYLE: 2** With back nut for cable bend relief¹ **IP50**

Size	L1 mm	D mm	AF A mm	K1 AF B mm	K2 AF B mm
0	≈ 35	9.4	8	7	7
1	≈ 44	12	10	10	10
A	≈ 45	13	11	12	12
2	≈ 48	15	13	12	13
3	≈ 58	18	16	15	15

TECHNICAL DATA

- Contact inserts from page 52

0 1 A 2 3

1 2 3 4 5 6 7 8 9 10 11 12 13 14 15 16 17 18 19

F C - P - 0

¹ Please order cable bend reliefs separately, see page 27.

CABLE ASSEMBLY – IN-LINE RECEPTACLE

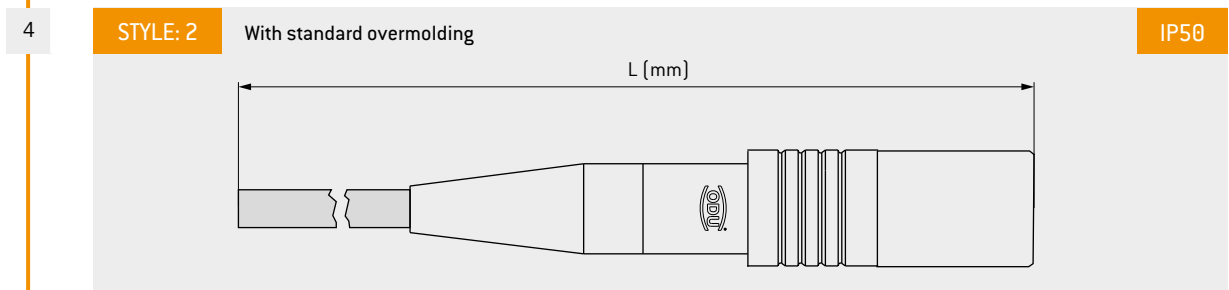
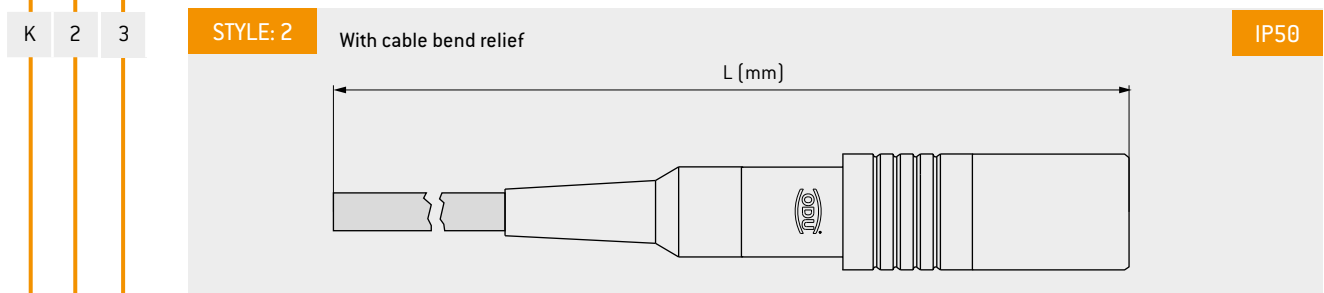
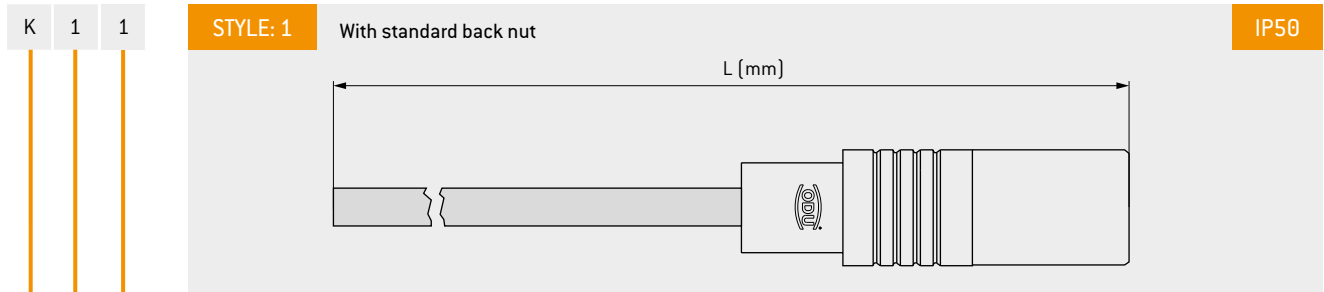

TECHNICAL DATA

- Contact inserts and cable types from page [52](#)

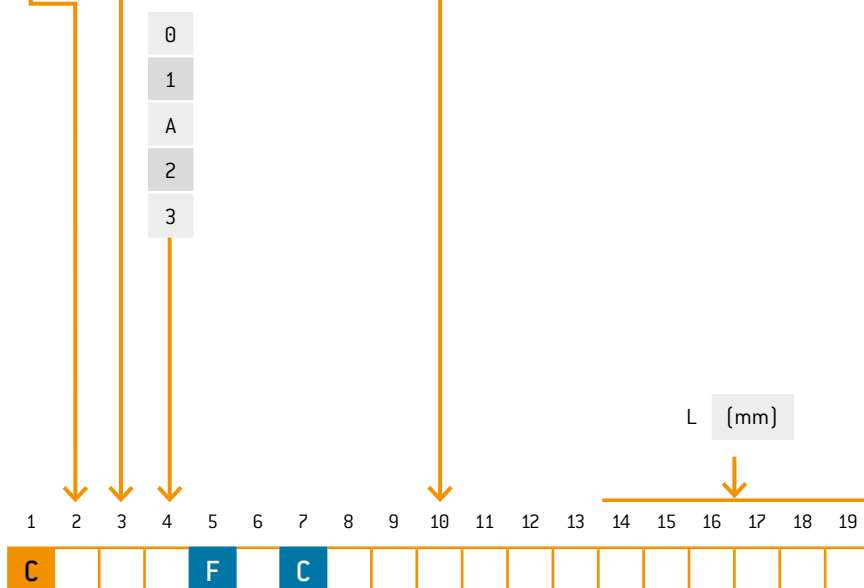

IN-LINE RECEPTACLE

Suitable for creating a cable-cable or cable-docking connection.

K 3 0 **STYLE: 3** With standard back nut **IP68**

K 4 S **STYLE: 4** With back nut for cable bend relief¹ **IP68**

Size	L1 mm	D mm	AF A mm	K3 AF B mm	K4 AF B mm
0	≈ 38	10	8	7	7
1	≈ 47	13	10	10	10
A	≈ 45	13	11	12	12
2	≈ 51	16	13	12	13

TECHNICAL DATA

- Contact inserts from page 52
- IP68 in mated condition

0 1 A 2

1 2 3 4 5 6 7 8 9 10 11 12 13 14 15 16 17 18 19

F C - P - 0

¹ Please order cable bend reliefs separately, see page 27.

CABLE ASSEMBLY – IN-LINE RECEPTACLE

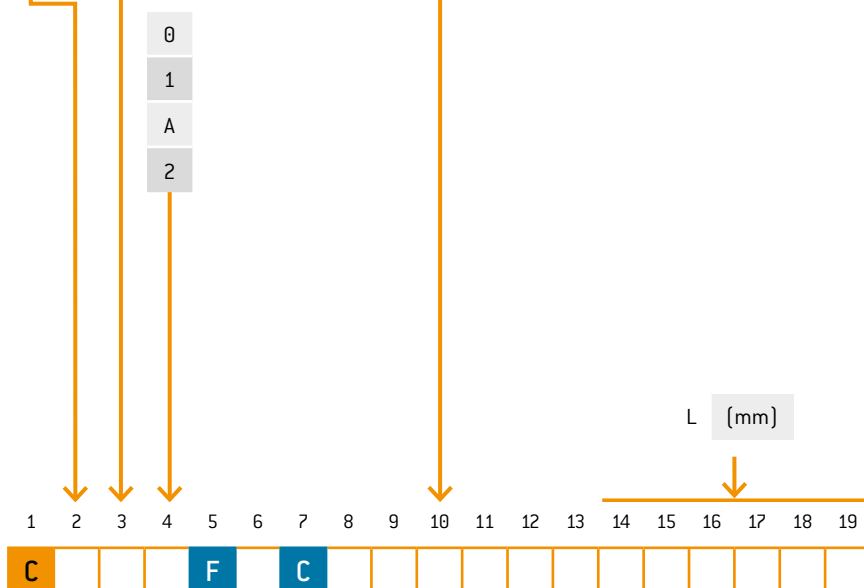
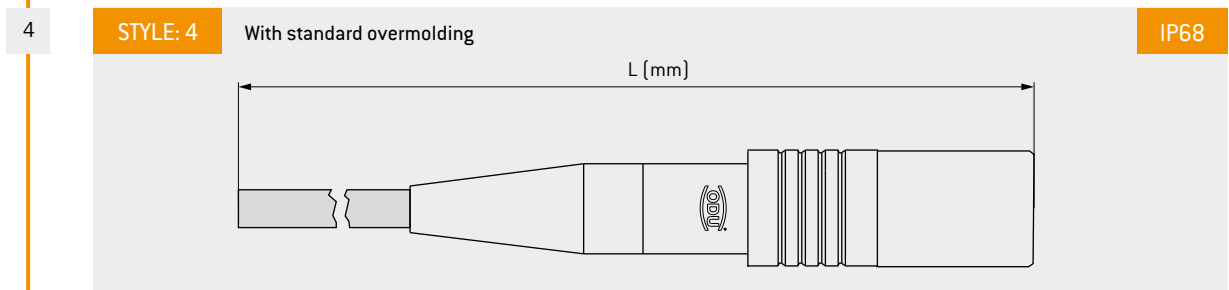
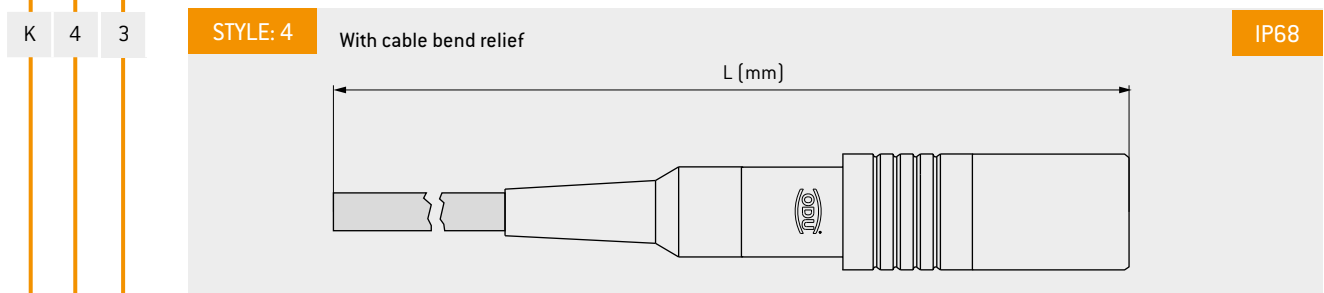
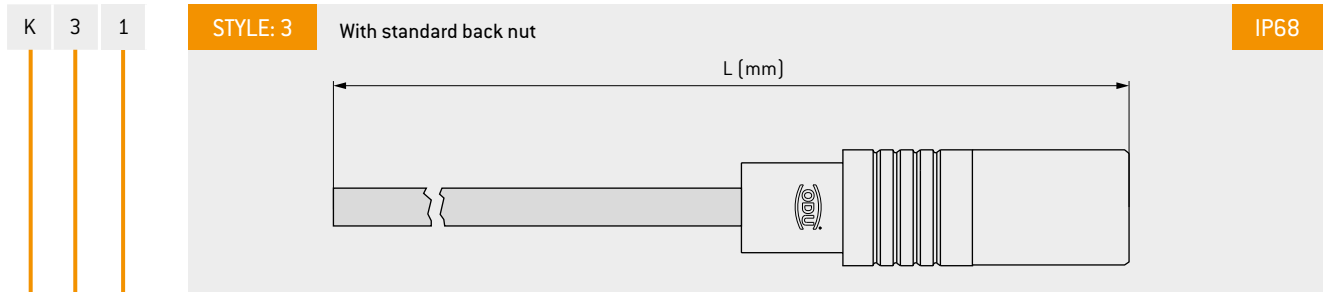

TECHNICAL DATA

- Contact inserts and cable types from page 52
- IP68 in mated condition

RECEPTACLE

G 1

STYLE: 1

IP50

Installation from front of panel

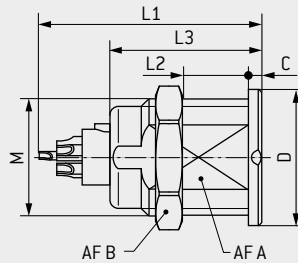

Size	L1 ¹ mm	L2 max mm	L3 ² mm	M mm	D mm	AF A mm	AF B mm	C mm	Panel cut-out			
									AF mm	∅ mm	Type	
0	0	≈ 20	≈ 9	14.5	9 × 0.5	10	8.2	11	1.5	8.3	9.1	A
1	1	≈ 24	≈ 8	16.5	12 × 1	14	10	14	1.5	10.1	12.1	A
A	1.5	≈ 25	≈ 8	15.5	14 × 1	16	12	17	2	12.1	14.1	D
2	2	≈ 27	≈ 10	18.5	15 × 1	18	14.1	17	2	14.2	15.1	B
3	3	≈ 30.5	≈ 13	22.5	18 × 1	22	16.5	22	2	16.6	18.1	A

0
1
A
2
3

Panel cut-out

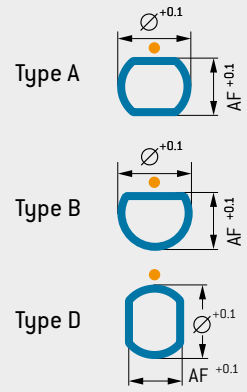

● Plug marking

TECHNICAL DATA

- Contact inserts from page 52
- PCB layouts see from page 53
- IP50 in reference to the tightness of the end device
- Anti-rotation feature
- Only straight PCB contact possible

G 2

STYLE: 2

IP68⁴

Installation from front of panel

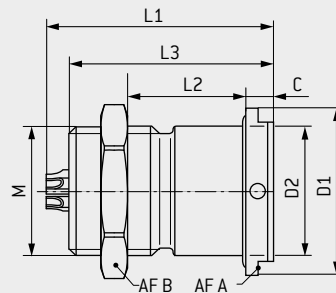

Size	L1 ¹ mm	L2 ³ mm	L3 ² mm	M mm	D1 mm	D2 mm	AF A mm	AF B mm	C mm	Panel cut-out		
										∅ mm	Type	
0	0	≈ 22.5	≈ 8	18.5	9 × 0.5	14.5	10	11	11	3	10.1	C
1	1	≈ 27	≈ 9	22.5	14 × 1	18	14	14	17	3	14.1	C
A	1.5	≈ 27	≈ 8	21.6	14 × 1	19	14	15	17	3.5	14.1	C
2	2	≈ 29.5	≈ 9	23	16 × 1	22	16	17	19	4	16.1	C
3	3	≈ 32	≈ 12	26.5	20 × 1	26	20	24	25	4	20.1	C

0
1
A
2
3

Panel cut-out



● Plug marking

TECHNICAL DATA

- Contact inserts from page 52
- PCB layouts see from page 53
- IP68 in mated and unmated condition
- Distance ring for wall-thickness adjustment see accessories see page 72
- No crimp contacts possible
- Only straight PCB contact possible

1 2 3 4 5 6 7 8 9 10 11 12 13 14 15 16 17 18 19

F C - P - 0 0

¹ L1 = maximum length including contact insert. ² L3 = Length of connector plug housing.
³ Minimum wall-thickness without use of distance rings. ⁴ Receptacle with potting see page 95, 3.Case.

CABLE ASSEMBLY – RECEPTACLE

G

1

0

1

A

2

3

STYLE: 1

Installation from front of panel

IP50

TECHNICAL DATA

- Contact inserts and cable types from page [52](#)
- IP50 in reference to the tightness of the end device
- Anti-rotation feature

G

2

0

1

A

2

3

STYLE: 2

Installation from front of panel

IP68⁴

TECHNICAL DATA

- Contact inserts and cable types from page [52](#)
- IP68 in mated and unmated condition
- Distance ring for wall-thickness adjustment see accessories see page [72](#)

L (mm)

1	2	3	4	5	6	7	8	9	10	11	12	13	14	15	16	17	18	19	
C						F													

⁴ Receptacle with potting see page [95](#), 3.Case.

SERIES F

45

RECEPTACLE

G 4

STYLE: 4

IP68³

Installation from front of panel, with minimized installation depth

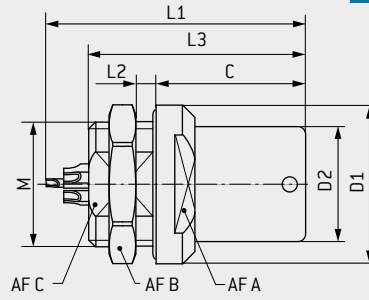

Panel cut-out

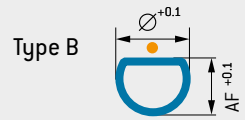
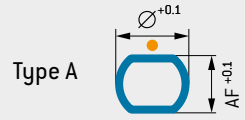

● Plug marking

Size	L1 ¹ mm	L2 max. mm	L3 ² mm	M mm	D1 mm	D2 mm	AF A mm	AF B mm	AF C mm	C mm	Panel cut-out			
											AF mm	∅ mm	Type	
0	0	≈ 22.5	≈ 4	17.5	9 × 0.5	14.5	10.5	12	11	8.2	11	8.3	9.1	A
1	1	≈ 27	≈ 4	22.5	14 × 1	18	13	14	17	12	15.5	12.1	14.1	A
A	1.5	≈ 28	≈ 5	21.6	14 × 1	19	13.5	15	17	12	13.6	12.1	14.1	A
2	2	≈ 32	≈ 4.5	23	16 × 1	21	16	17	19	14	15.5	14.1	16.1	A
3	3	≈ 34.5	≈ 7	29	18 × 1	26	19	22	22	17.2	19	17.3	18.1	B

TECHNICAL DATA

- Contact inserts from page 52
- PCB layouts see from page 53
- IP68 in mated and unmated condition
- Anti-rotation feature
- No crimp contacts possible
- Only straight PCB contact possible

1 2 3 4 5 6 7 8 9 10 11 12 13 14 15 16 17 18 19

F C - P - 0 0

¹ L1 = maximum length including contact insert. ² L3 = Length of connector plug housing.
³ Receptacle with potting see page 95, 3.Case.

CABLE ASSEMBLY – RECEPTACLE

G

4

0

1

A

2

3

STYLE: 4

Installation from front of panel

IP68³

TECHNICAL DATA

- Contact inserts and cable types from page [52](#)
- IP68 in mated and unmated condition
- Anti-rotation feature

³ Receptacle with potting see page [95](#), 3.Case.

RECEPTACLE

G 5

STYLE: 5

IP50

With continuous thread, installation from front or rear of panel with optimal distance adjustment

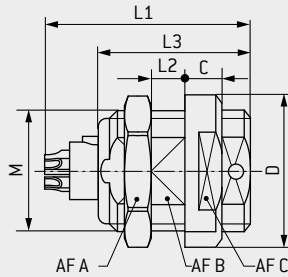

Panel cut-out

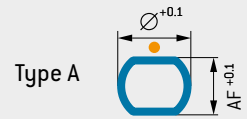

● Plug marking

Size	L1 ¹ mm	L2 max. mm	L3 ² mm	M mm	D mm	AF A mm	AF B mm	AF C mm	C mm	Panel cut-out			
										AF mm	∅ mm	Type	
0	0	≈ 20	≈ 8	14.5	9 × 0.5	11.5	11	8	10	2.5	8.1	9.1	A
1	1	≈ 24	≈ 8	16.5	12 × 1	15	14	10	13	4	10.1	12.1	A
A	1.5	≈ 25	≈ 7	15.5	14 × 1	19	17	12	17	3	12.1	14.1	A
2	2	≈ 27	≈ 10	18.5	15 × 1	20	17	13.5	17	4	13.6	15.1	A
3	3	≈ 30.5	≈ 12	22.5	18 × 1	23	22	16.5	20	5	16.6	18.1	A

TECHNICAL DATA

- Contact inserts from page 52
- PCB layouts see from page 53
- IP50 in reference to the tightness of the end device
- Anti-rotation feature
- Right-angled PCB contact possible, see page 70

G 8

STYLE: 8

IP68³

Installation from rear of panel, with designer nut

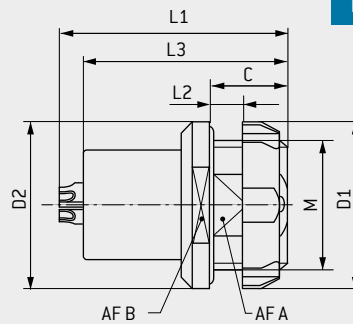

Panel cut-out

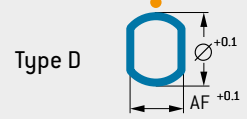
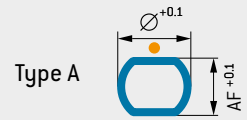

● Plug marking

Size	L1 ¹ mm	L2 max. mm	L3 ² mm	M mm	D1 mm	D2 mm	AF A mm	AF B mm	C mm	Panel cut-out			
										AF mm	∅ mm	Type	
0	0	≈ 22.5	≈ 3.5	17	9 × 0.5	12	14	8.2	11	6.5	8.3	9.1	D
1	1	≈ 27.5	≈ 4	21	14 × 1	18	18	12	–	8	12.1	14.1	A
A	1.5	≈ 27	≈ 3	19.5	14 × 1	18	19	12	–	7	12.1	14.1	D
2	2	≈ 29.5	≈ 3	23	16 × 1	22	21	14.3	–	8	14.4	16.1	A
3	3	≈ 32	≈ 6	26.5	20 × 1	25	26	18	–	11	18.1	20.1	A

TECHNICAL DATA

- Contact inserts from page 52
- PCB layouts see from page 53
- IP68 in mated and unmated condition
- Anti-rotation feature
- No crimp contacts possible
- Assembly wrench page 86
- Right-angled PCB contact possible, see page 70

1 2 3 4 5 6 7 8 9 10 11 12 13 14 15 16 17 18 19

F C - P - 0 0

¹ L1 = maximum length including contact insert. ² L3 = Length of connector plug housing.
³ Receptacle with potting see page 95, 3.Case.

CABLE ASSEMBLY – RECEPTACLE

G

5

0

1

A

2

3

STYLE: 5

Installation from front of panel

IP50

TECHNICAL DATA

- Contact inserts and cable types from page [52](#)
- IP50 in reference to the tightness of the end device
- Anti-rotation feature

G

8

0

1

A

2

3

STYLE: 8

Installation from front of panel

IP68³

TECHNICAL DATA

- Contact inserts and cable types from page [52](#)
- IP68 in mated and unmated condition
- Anti-rotation feature
- Assembly wrench page [86](#)

L (mm)

L (mm)

1

2

3

4

5

6

7

8

9

10

11

12

13

14

15

16

17

18

19

C

F

C

³ Receptacle with potting see page [95](#), 3.Case.

SERIES F

49

RECEPTACLE

G H

STYLE: H

IP50

Protruding receptacle with reduced installation depth, suitable for front installation

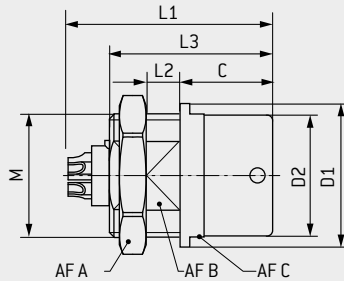

Panel cut-out

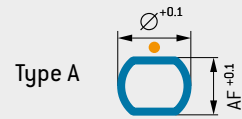

● Plug marking

Size	L1 ¹ mm	L2 max. mm	L3 ² mm	M mm	D1 mm	D2 mm	AF A mm	AF B mm	AF C mm	C mm	Panel cut-out			
											AF mm	∅ mm	Type	
0 ³	0 ³	≈ 20	≈ 3	16	9 × 0.5	11	9	11	8.2	–	11	8.3	9.1	A
1 ³	1 ³	≈ 24	≈ 4.5	17.5	12 × 1	14	11.7	14	10	12	10	10.1	12.1	A
A ³	1.5 ³	≈ 26	≈ 5	17	14 × 1	18	13.5	17	12	15	10	12.1	14.1	A
2 ³	2 ³	≈ 27	≈ 5.5	19.5	16 × 1	19	16	19	13.5	17	11	13.6	16.1	A

TECHNICAL DATA

- Contact inserts from page 52
- PCB layouts see from page 53
- IP50 in reference to the tightness of the end device
- Anti-rotation feature
- Only straight PCB contact possible

G K

STYLE: K

IP50

Installation from rear of panel, with slight installation depth

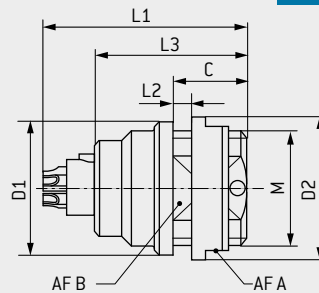

Panel cut-out

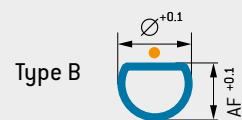
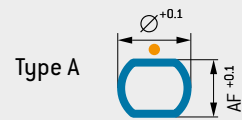

● Plug marking

Size	L1 ¹ mm	L2 max. mm	L3 ² mm	M mm	D1 mm	D2 mm	AF A mm	AF B mm	C mm	Panel cut-out			
										AF mm	∅ mm	Type	
0	0	≈ 20	≈ 3	14.5	9 × 0.5	11	11.5	10	8	6.5	8.1	9.1	A
1	1	≈ 24	≈ 4	16.5	12 × 1	14	15	13	11	8	11.1	12.1	B
2	2	≈ 27	≈ 5	18.5	15 × 1	19	20	17	14	9	14.1	15.1	B
3	3	≈ 30.5	≈ 12	22.5	18 × 1	22	23	20	17.2	17	17.3	18.1	B

TECHNICAL DATA

- Contact inserts from page 52
- PCB layouts see from page 53
- IP50 in reference to the tightness of the end device
- Anti-rotation feature
- Right-angled PCB contact possible, see page 70

1 2 3 4 5 6 7 8 9 10 11 12 13 14 15 16 17 18 19

F C - P - 0 0

¹ L1 = maximum length including contact insert ² L3 = Length of connector plug housing ³ On request

CABLE ASSEMBLY – RECEPTACLE

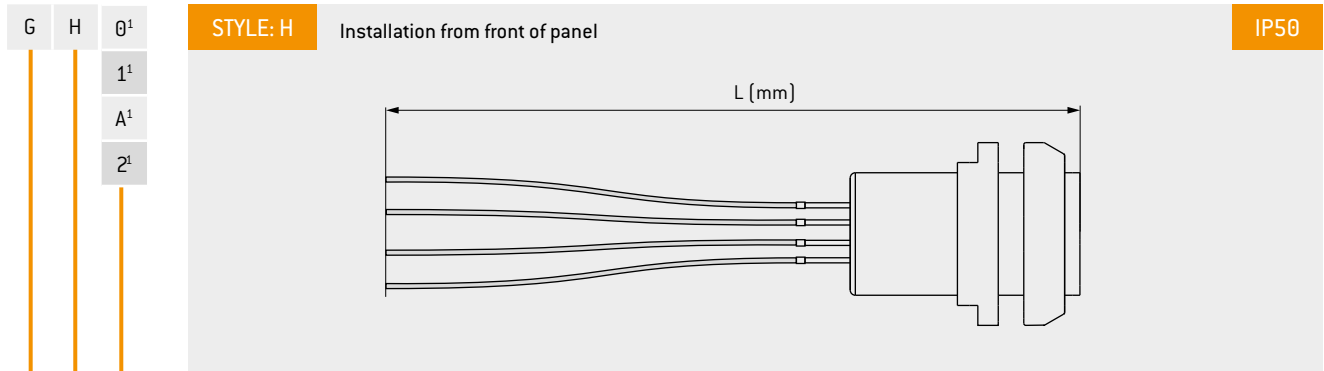

TECHNICAL DATA

- Contact inserts and cable types from page 52
- IP50 in reference to the tightness of the end device
- Anti-rotation feature

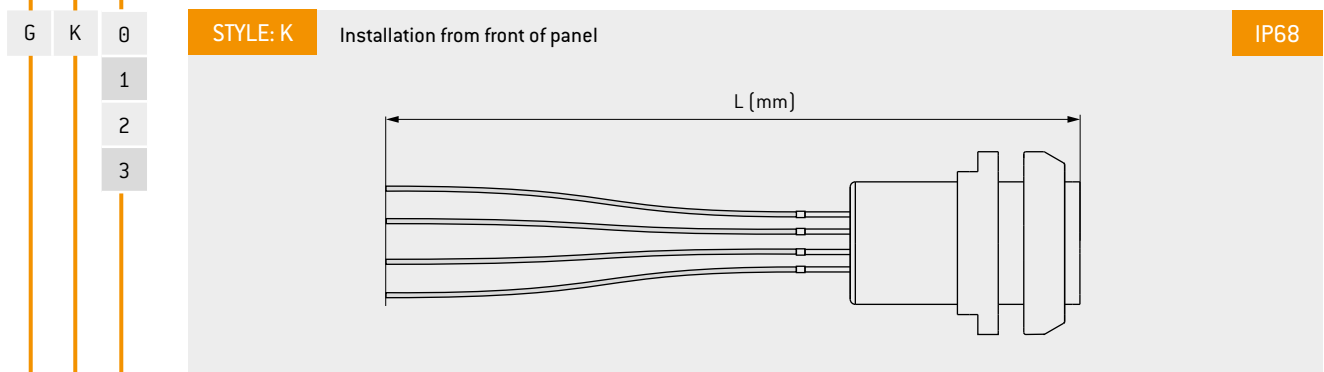

TECHNICAL DATA

- Contact inserts and cable types from page 52
- IP68 in reference to the tightness of the end device
- Anti-rotation feature

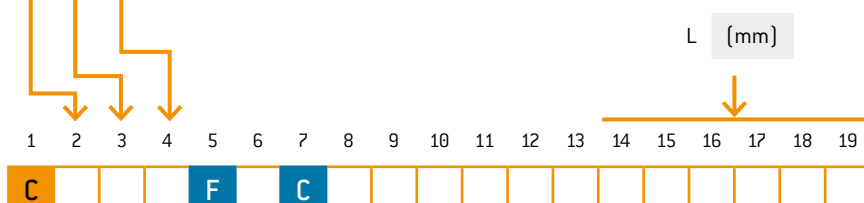

¹ On request



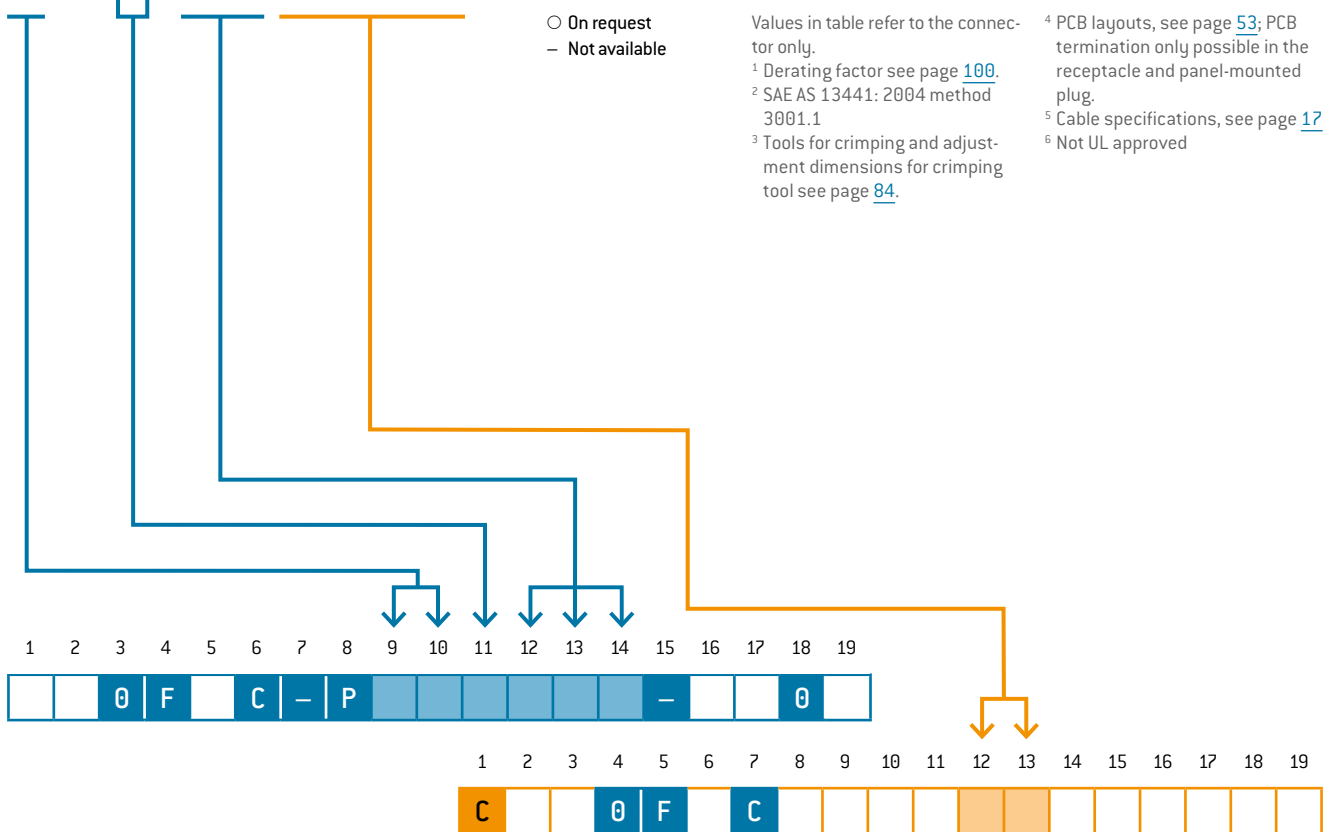

CONTACT INSERTS AND CABLE TYPES (SIZE 0)

Number of contacts	Contact type			Part number key		Cable PVC unshielded ⁵	Cable PVC shielded ⁵	Cable PUJ unshielded ⁵	Cable PUJ shielded ⁵	Single wires ⁵	Contact diameter mm	Single contact nominal current ¹ A	Clearance and creepage distance		Test voltage ² SAE kV RMS	Termination Ø mm	Termination cross section		View on termination area			
	Termination	Socket	Pin										Contact to contact mm	Contact to housing mm			AWG	mm ²	Pin piece	Socket piece		
																					mm	A
02	Solder	L	M	J	G	0	ZZ	XZ	0	TZ	ZZ	0.9	7.5	1.0	0.8	1.50	0.85	22	0.38			
				J	G	0	ZY	XY	0	TY	ZY			1.3								
03	Solder	L	M	J	G	0	ZZ	XZ	VZ ⁵	TZ	ZZ	0.9	7.5	0.6	0.9	1.20	0.85	22	0.38			
				J	G	0	ZY	XY	VZ ⁵	TY	ZY			0.9								0.8
04	Solder	L	M	F	G	0	ZX	XX	VX	TX	ZX	0.7	7.5	0.6	0.7	0.90	0.85	22	0.38			
				F	G	0	ZW	XW	VW	TW	ZW		5									0.8
				F	D	0	ZV	XV	VV	TV	ZV		7.5									0.7
	Crimp ³	N	P	F	G	0	-	-	-	-	-	0.7	5	1.1	0.7	0.90	-	22-26	0.38-0.15			
				F	C	0	-	-	-	-	-		5									
				F	0	0	-	-	-	-	-		5									
05	Solder	L	M	F	G	0	ZX	XX	VX	TX	ZX	0.7	7.5	0.5	0.6	0.60	0.85	22	0.38			
				F	G	0	ZW	XW	VW	TW	ZW		5									0.6
	PCB ⁴	Q	R	F	D	0	ZV	XV	VV	TV	ZV	0.7	5	0.6	0.6	1.10	0.6	26	0.15			
				F	D	0	ZU	XU	VU	TU	ZU		0.9									0.5
07	Solder	L	M	C	C	0	0	XT	0	TT	ZT	0.5	4	0.7	0.6	0.90	0.4	28	0.08			
				C	C	0	0	XS	0	TS	ZS											0.9
09	Solder	L	M	C	C	0	0	0	0	ZT	0.5	4	0.6	0.5	0.60	0.4	28	0.08				
				C	C	0	0	0	0	ZS											0.7	0.5

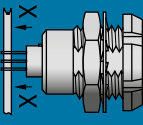
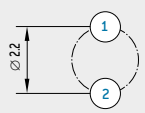
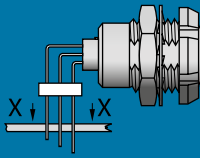

PCB LAYOUTS

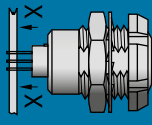
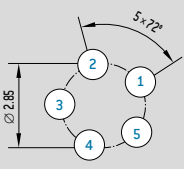
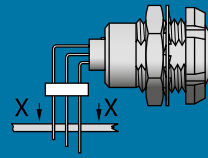
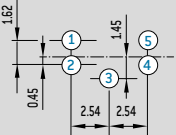
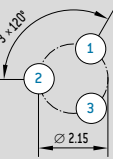
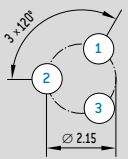
For PCB contacts (size 0)

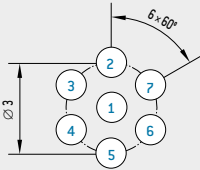
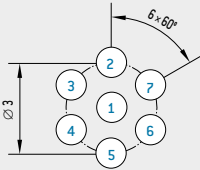
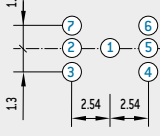
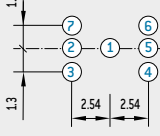
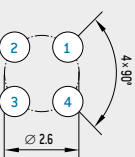
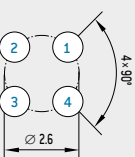
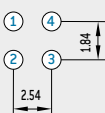
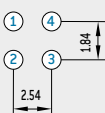
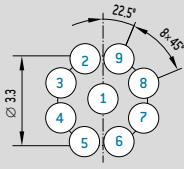
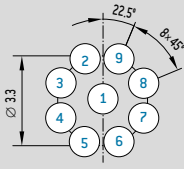
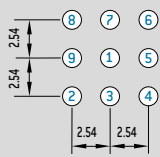
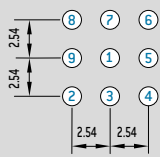
	Straight	90° right-angled		Straight	90° right-angled
2 contacts	 <p>Hole: 0.8 mm</p> 	 <p>Hole: 0.7 mm</p> 		 <p>Hole: 0.6 mm</p> 	 <p>Hole: 0.6 mm</p> 
3 contacts	 <p>Hole: 0.8 mm</p> 	 <p>Hole: 0.7 mm</p> 		 <p>Hole: 0.6 mm</p> 	 <p>Hole: 0.6 mm</p> 
4 contacts	 <p>Hole: 0.6 mm</p> 	 <p>Hole: 0.6 mm</p> 		 <p>Hole: 0.6 mm</p> 	 <p>Hole: 0.6 mm</p> 

All specifications are only valid for socket inserts.

Pin inserts on request

CONTACT INSERTS AND CABLE TYPES (SIZE 1)

Number of contacts	Contact type		Part number key			Cable type					Contact diameter mm	Single contact nominal current ¹ A	Clearance and creepage distance		Test voltage ² SAE kV RMS	Termination ∅ mm	Termination cross section		View on termination area	
	Termination	Socket	Pin	P	N	∅	Cable PVC unshielded ⁵	Cable PVC shielded ⁵	Cable PUJF unshielded ⁵	Cable PUJF shielded ⁵			Single wires ⁵	Contact to contact mm			Contact to housing mm	AWG	mm ²	Pin piece
02	Solder	L	M	P	N	∅	ZR	XR	VR	TR	ZR	1.3	14	0.8	1.65	1.4	18	1.0		
				P	H	∅	ZP	XP	VP	TP	ZP		11							
	M	P	H	∅	ZO	XO	VO	TO	ZO	1.5	0.7		-	-						
	PCB ⁴	Q	R	P	∅	∅	-	-	-	-	-		-	-		-	-	-		
03	Solder	L	M	P	N	∅	ZR	XR	VR	TR	ZR	1.3	14	0.5	1.00	1.4	18	1.0		
				P	H	∅	ZP	XP	VP	TP	ZP		11							
	M	P	H	∅	ZO	XO	VO	TO	ZO	1.2	0.7		-	-						
	PCB ⁴	Q	R	P	∅	∅	-	-	-	-	-		-	-		-	-	-		
04	Solder	L	M	J	G	∅	ZZ	XZ	VZ	TZ	ZZ	0.9	7.5	1.2	1.50	0.85	22	0.38		
				J	H	∅	-	-	-	-	-		9							
	N	P	J	G	∅	-	-	-	-	7.5	1.5		-	22-26		0.38-0.15				
	PCB ⁴	Q	R	J	∅	∅	-	-	-	-	1.2		0.8	0.7		-	-			
05	Solder	L	M	J	H	∅	ZN	XN	VN	TN	ZN	0.9	9	0.5	1.00	1.1	20	0.50		
				J	H	∅	ZM	XM	VM	TM	ZM		7.5							
	M	J	G	∅	ZZ	XZ	VZ	TZ	ZZ	9	1.0		-	-		20-24	0.50-0.25			
	PCB ⁴	Q	R	J	∅	∅	-	-	-	-	7.5		0.8	0.8		1.35	0.7	-		
06	Solder	L	M	F	G	∅	ZX	XX	VX	TX	ZX	0.7	7.5	0.6	1.00	0.85	22	0.38		
				F	G	∅	ZW	XW	VW	TW	ZW		5							
	M	F	D	∅	ZV	XV	VV	TV	ZV	7.5	0.7		0.6	-		-	22-26	0.38-0.15		
	PCB ⁴	Q	R	F	∅	∅	-	-	-	-	5		1.1	0.8		1.20	0.5	-		

○ On request
 – Not available

Values in table refer to the connector only.

¹ Derating factor see page 100.

² SAE AS 13441: 2004 method 3001.1

³ Tools for crimping and adjustment dimensions for crimping tool see page 84.

⁴ PCB layouts, see page 53; PCB termination only possible in the receptacle and panel-mounted plug

⁵ Cable specifications, see page 17

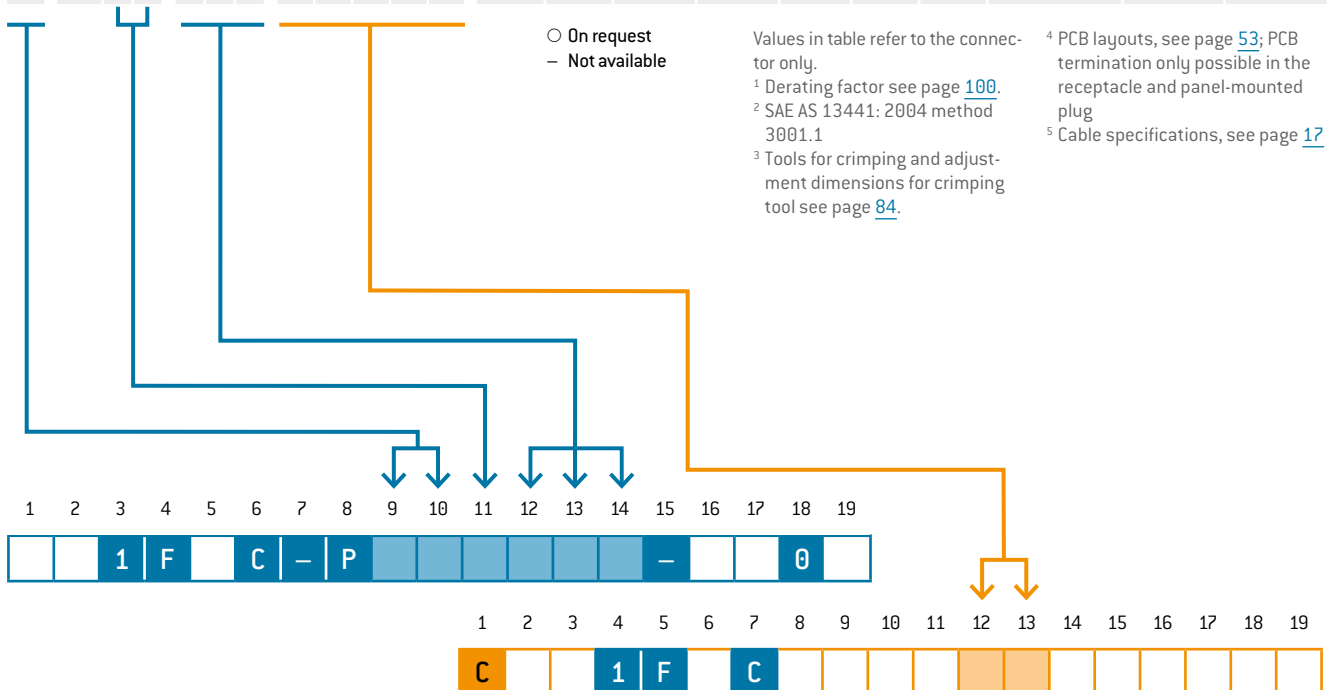

PCB LAYOUTS

For PCB contacts (size 1)

	Straight	90° right-angled
2 contacts	Hole: 0.8 mm 	Hole: 0.9 mm
3 contacts	Hole: 0.8 mm 	Hole: 0.9 mm
4 contacts	Hole: 0.8 mm 	Hole: 0.7 mm
5 contacts	Hole: 0.8 mm 	Hole: 0.7 mm
6 contacts	Hole: 0.6 mm 	Hole: 0.7 mm

All specifications are only valid for socket inserts.
 Pin inserts on request

PCB LAYOUTS

For PCB contacts (size 1)

	Straight	90° right-angled
7 contacts	<p>Hole: 0.6 mm</p>	<p>Hole: 0.7 mm</p>
8 contacts	<p>Hole: 0.6 mm</p>	on request
10 contacts	<p>Hole: 0.6 mm</p>	-
12 contacts	<p>Hole: 0.6 mm</p>	on request
14 contacts	<p>Hole: 0.6 mm</p>	-

All specifications are only valid for socket inserts.
Pin inserts on request

CONTACT INSERTS AND CABLE TYPES (SIZE 1.5)

Number of contacts	Contact type			Part number key					Cable PVC unshielded ⁵	Cable PVC shielded ⁵	Cable RJ45 unshielded ⁵	Cable RJ45 shielded ⁵	Single wires ⁵	Contact diameter mm	Single contact nominal current ¹ A	Clearance and creepage distance		Test voltage ² SAE kV RMS	Termination Ø mm	Termination cross section		View on termination area	
	Termination	Socket	Pin	F	G	Ø	ZX	XX								VX	TX			ZX	Contact to contact mm	Contact to housing mm	SAE
10	Solder	L	M	F	G	Ø	ZX	XX	VX	TX	ZX	0.7	7.5	0.6	0.6	1.00	0.85	22	0.38				
				F	D	Ø	ZV	XV	VV	TV	ZV		5									0.8	1.20
	PCB ⁴	Q	R	F	Ø	Ø	-	-	-	-	-		0.4	0.5	-		-	-	-			-	-
12	Solder	L	M	F	G	Ø	ZX	XX	VX	TX	ZX	0.7	7.5	0.4	0.7	1.00	0.85	22	0.38				
				F	D	Ø	ZV	XV	VV	TV	ZV		5									0.6	1.20
	PCB ⁴	Q	R	F	Ø	Ø	-	-	-	-	-		0.9	1.00	-	22 – 26	0.38 – 0.15	-	-				
													5	0.3	1.20	-	28 – 32	0.09 – 0.04	-			-	
	Crimp ³	N	P	F	G	Ø	-	-	-	-	-		7.5	0.9	-	-	-	-	-			-	-
													5	0.3	-	-	-	-	-			-	-
19	Solder	L	M	C	C	Ø	○	○	○	TT	ZT	0.5	4	0.6	0.6	1.00	0.4	28	0.08				
				C	C	Ø	○	○	○	TS	ZS											0.3	0.5
	PCB ⁴	Q	R	C	Ø	Ø	-	-	-	-	-												

SPECIFIC INSERTS FOR HIGH DATA TRANSMISSION RATES

Ethernet⁶
Type CAT 5e
up to 1 Gbit

D8 ⁷	Solder	L	F	G	9	○	○	○	○	○	0.7	7.5	0.7	1.8	1.20	0.85	22	0.38			
	PCB ⁴	Q	F	Ø	9	-	-	-	-	-		5	1.4	1.2		0.5	-	-			-
	Solder	M	F	G	9	○	○	○	○	○		7.5	0.7	0.7		0.85	22	0.38			

○ On request
– Not available

Values in table refer to the connector only.

¹ Derating factor see page 100.

² SAE AS 13441: 2004 method 3001.1

³ Tools for crimping and adjustment dimensions for crimping tool see page 84.

⁴ PCB layouts, see page 53; PCB termination only possible in the receptacle and panel-mounted plug

⁵ Cable specifications, see page 17

⁶ ISO/IEC 11801:2017. Further information on request

⁷ Not compatible to competition

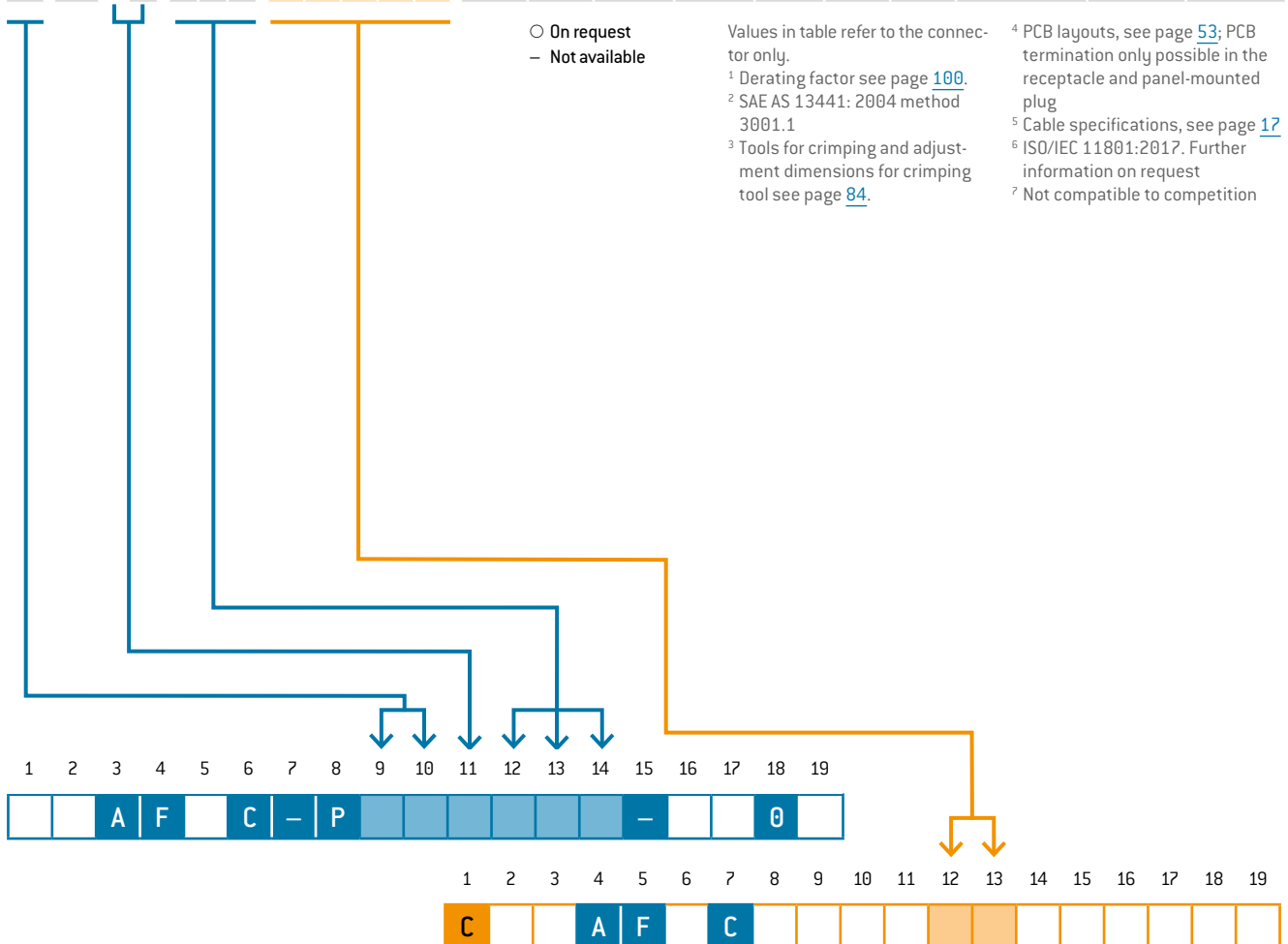

PCB LAYOUTS

For PCB contacts [size 1.5]

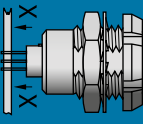
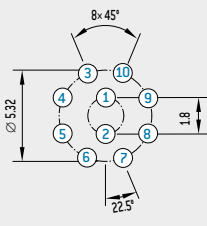
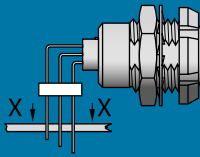
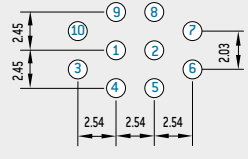
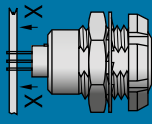
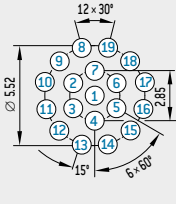
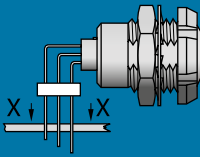
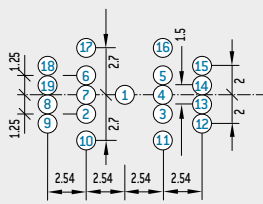
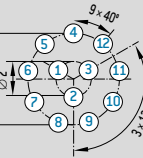
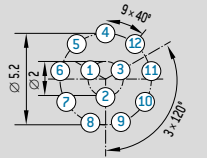
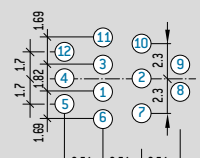
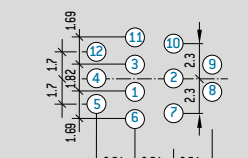
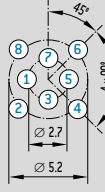
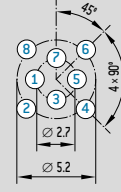
	Straight	90° right-angled	Straight	90° right-angled	
10 contacts	 <p>Hole: 0.6 mm</p> 	 <p>Hole: 0.7 mm</p> 	19 contacts	 <p>Hole: 0.6 mm</p> 	 <p>Hole: 0.6 mm</p> 
12 contacts	 <p>Hole: 0.6 mm</p> 	 <p>Hole: 0.7 mm</p> 	Ethernet 8 contacts	 <p>Hole: 0.6 mm</p> 	on request

All specifications are only valid for socket inserts.

Pin inserts on request

CONTACT INSERTS AND CABLE TYPES (SIZE 2)

Number of contacts	Contact type		Part number key	Cable type					Contact diameter mm	Single contact nominal current ¹ A	Clearance and creepage distance		Test voltage ² SAE kV RMS	Termination ∅ mm	Termination cross section		View on termination area					
	Termination	Socket		Pin	Cable PVC unshielded ⁵	Cable PVC shielded ⁵	Cable PU unshielded ⁵	Cable PU shielded ⁵			Single wires ⁵	Contact to contact mm			Contact to housing mm	AWG	mm ²	Pin piece	Socket piece			
02	Solder	L	M	S	N	∅	ZH	XH	VH	TH	ZH	1.6	14.5	2.1	1.6	2.10	1.4	18	1.00			
				S	N	∅	ZG	XG	VG	TG	ZG											
03	PCB ⁴	Q	R	S	∅	∅	-	-	-	-	-	1.6	14.5	2.5	1.5	1.80	1.0	-	-			
				S	∅	∅	-	-	-	-	-											
05	Solder	L	M	P	N	∅	ZR	XR	VR	TR	ZR	1.3	14	0.7	1.1	1.10	1.4	18	1.00			
				P	N	∅	ZQ	XQ	VQ	TQ	ZQ											
				P	H	∅	ZP	XP	VP	TP	ZP											
	Crimp ³	N	P	P	P	L	∅	-	-	-	-	-	1.3	14	1.2	1.1	1.50	1.1	20	0.50		
					P	H	∅	-	-	-	-	-										
					P	H	∅	-	-	-	-	-										
PCB ⁴	Q	R	P	∅	∅	∅	-	-	-	-	-	1.3	11	1.0	0.9	1.10	-	18-20	1.00-0.50			
				∅	∅	∅	-	-	-	-	-											
06	Solder	L	M	J	H	∅	ZN	XN	VN	TN	ZN	0.9	9	1.2	1.2	1.50	1.1	20	0.50			
				J	H	∅	ZM	XM	VM	TM	ZM											
	PCB ⁴	Q	R	J	J	G	∅	ZZ	XZ	VZ	TZ	ZZ	0.9	7.5	1.5	1.2	1.80	0.85	22	0.38		
					J	G	∅	ZY	XY	VY	TY	ZY										
07	Solder	L	M	J	H	∅	ZN	XN	VN	TN	ZN	0.9	9	0.7	1.0	0.90	1.1	20	0.50			
				J	H	∅	ZM	XM	VM	TM	ZM											
	PCB ⁴	Q	R	J	J	G	∅	ZZ	XZ	VZ	TZ	ZZ	0.9	7.5	1.0	1.0	1.65	0.85	22	0.38		
					J	G	∅	ZY	XY	VY	TY	ZY										
08	Solder	L	M	J	H	∅	ZN	XN	VN	TN	ZN	0.9	9	0.7	1.1	0.90	1.1	20	0.50			
				J	H	∅	ZM	XM	VM	TM	ZM											
	PCB ⁴	Q	R	J	J	G	∅	ZZ	XZ	VZ	TZ	ZZ	0.9	7.5	1.0	1.1	1.50	0.85	22	0.38		
					J	G	∅	ZY	XY	VY	TY	ZY										
PCB ⁴	Q	R	C	∅	∅	∅	-	-	-	-	-	0.9	7.5	1.3	1.1	0.7	-	-				
				∅	∅	∅	-	-	-	-	-											

○ On request
 – Not available

Values in table refer to the connector only.

¹ Derating factor see page 100

² SAE AS 13441: 2004 method 3001.1

³ Tools for crimping and adjustment dimensions for crimping tool see page 84

⁴ PCB layouts, see page 53; PCB termination only possible in the receptacle and panel-mounted plug

⁵ Cable specifications, see page 17

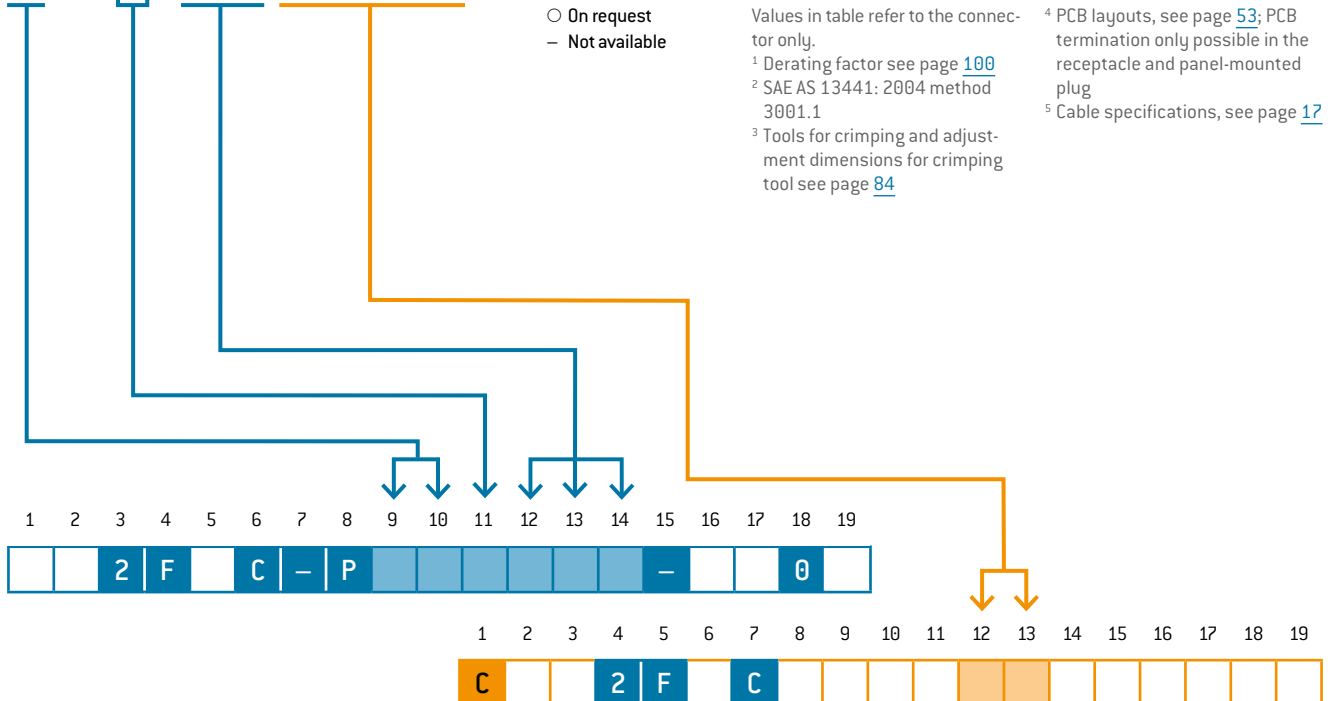

PCB LAYOUTS

For PCB contacts [size 2].

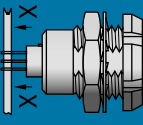
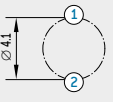
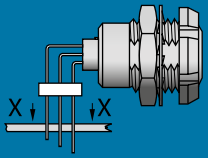
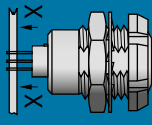
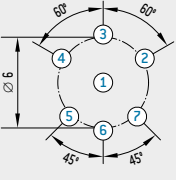
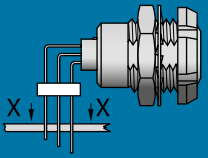
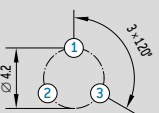
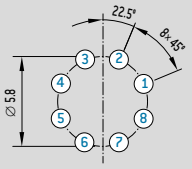
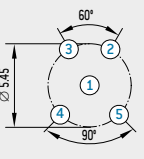
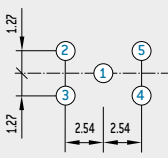
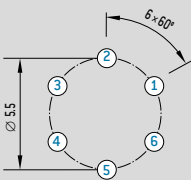
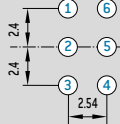
	Straight	90° right-angled		Straight	90° right-angled
2 contacts	 <p>Hole: 1.1 mm</p> 	 <p>on request</p>		 <p>Hole: 0.8 mm</p> 	 <p>on request</p>
3 contacts	<p>Hole: 1.1 mm</p> 	<p>on request</p>		<p>Hole: 0.8 mm</p> 	<p>on request</p>
5 contacts	<p>Hole: 0.8 mm</p> 	<p>Hole: 0.9 mm</p> 			
6 contacts	<p>Hole: 0.8 mm</p> 	<p>Hole: 0.7 mm</p> 			

All specifications are only valid for socket inserts.
Pin inserts on request

CONTACT INSERTS AND CABLE TYPES (SIZE 2)

Number of contacts	Contact type			Part number key		Cable type					Contact diameter mm	Single contact nominal current ¹ A	Clearance and creepage distance		Test voltage ² SAE kV RMS	Termination Ø mm	Termination cross section		View on termination area			
	Termination	Socket	Pin			Cable PVC unshielded ⁵	Cable PVC shielded ⁵	Cable PUJ unshielded ⁵	Cable PUJ shielded ⁵	Single wires ⁵			Contact to contact mm	Contact to housing mm			AWG	mm ²	Pin piece	Socket piece		
09	Solder	L		M	0	0	○	○	VF	TF	ZF	8 x 0.9 1 x 1.3	7.5	0.8	1.35	0.85	22	0.38				
		M		M	0	0	○	○	VE	TE	ZE		1.1	1.8			20	0.50				
	PCB ⁴	Q	R	M	0	0	-	-	-	-	-	7.5	1.1	2.1	0.7	-	-	-	-	-		
10 ⁵	Solder	L		J	H	9	ZD	XD	VD	TD	ZD	0.9	9	0.6	0.90	1.1	20	0.50				
		M		J	H	9	ZC	XC	VC	TC	ZC		7.5	0.9			1.50	0.85			22	0.38
		L		J	G	9	ZB	XB	VB	TB	ZB		9	1.2			0.90	-			20 - 24	0.50 - 0.25
	Crimp ³	N	P	J	G	9	-	-	-	-	-	7.5	1.2	1.50	-	22 - 26	0.38 - 0.15					
		PCB ⁴	Q	R	J	0	9	-	-	-	-	7.5	1.2	1.50	0.7	-	-			-	-	
		L		J	G	9	-	-	-	-	-	7.5	1.2	1.50	0.7	-	-			-	-	
11	Solder	L		J	G	0	○	○	○	TZ	ZZ	0.9	7.5	0.8	1.35	0.85	22	0.38				
		M		J	G	0	○	○	○	TY	ZY		7.5	1.1			0.7	-			-	
	PCB ⁴	Q	R	J	0	0	-	-	-	-	-	7.5	1.1	0.7	-	-	-	-	-			
12 ⁶	Solder	L		F	G	9	Z9	X9	V9	T9	Z9	0.7	7.5	0.7	1.20	0.85	22	0.38				
		M		F	G	9	Z8	X8	V8	T8	Z8		5	0.9			1.35	0.6			26	0.15
		L		F	D	9	Z7	X7	V7	T7	Z7		7.5	0.9			1.20	-			22 - 26	0.38 - 0.15
	Crimp ³	N	P	F	G	9	-	-	-	-	-	5	1.2	1.35	-	28 - 32	0.09 - 0.04					
		PCB ⁴	Q	R	F	0	9	-	-	-	-	5	1.2	1.35	0.5	-	-			-	-	
		L		F	G	9	-	-	-	-	-	5	1.2	1.35	0.5	-	-			-	-	
16	Solder	L		F	G	0	ZX	XX	VX	TX	ZX	0.7	7.5	0.6	0.90	0.85	22	0.38				
		M		F	G	0	ZW	XW	VW	TW	ZW		5	0.8			1.10	0.6			26	0.15
		L		F	D	0	ZV	XV	VV	TV	ZV		7.5	0.7			0.90	-			22 - 26	0.38 - 0.15
	Crimp ³	N	P	F	G	0	-	-	-	-	-	5	1.1	1.10	-	28 - 32	0.09 - 0.04					
		PCB ⁴	Q	R	F	0	0	-	-	-	-	5	1.1	1.10	0.5	-	-			-	-	
		L		F	G	0	-	-	-	-	-	5	1.1	1.10	0.5	-	-			-	-	
19	Solder	L		F	G	0	ZX	XX	VX	TX	ZX	0.7	7.5	0.5	0.90	0.85	22	0.38				
		M		F	G	0	ZW	XW	VW	TW	ZW		5	0.7			1.00	0.6			26	0.15
		L		F	D	0	ZV	XV	VV	TV	ZV		7.5	0.7			0.90	-			22 - 26	0.38 - 0.15
	Crimp ³	N	P	F	G	0	-	-	-	-	-	5	1.0	1.00	-	28 - 32	0.09 - 0.04					
		PCB ⁴	Q	R	F	0	0	-	-	-	-	5	1.0	1.00	0.5	-	-			-	-	
		L		F	G	0	-	-	-	-	-	5	1.0	1.00	0.5	-	-			-	-	

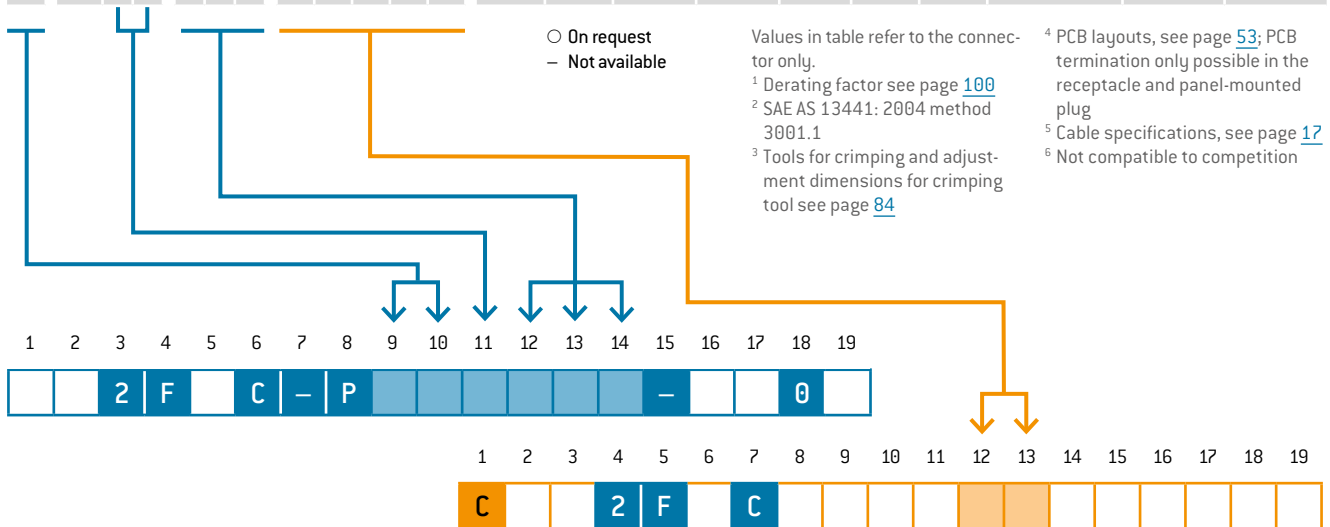

PCB LAYOUTS

For PCB contacts (size 2)

	Straight	90° right-angled		Straight	90° right-angled
9 contacts	Hole: 0.8 mm 	on request 		Hole: 0.6 mm 	Hole: 0.7 mm
10 contacts	Hole: 0.8 mm 	—		Hole: 0.6 mm 	—
11 contacts	Hole: 0.8 mm 	Hole: 0.7 mm 			
12 contacts	Hole: 0.6 mm 	—			

All specifications are only valid for socket inserts.
Pin inserts on request



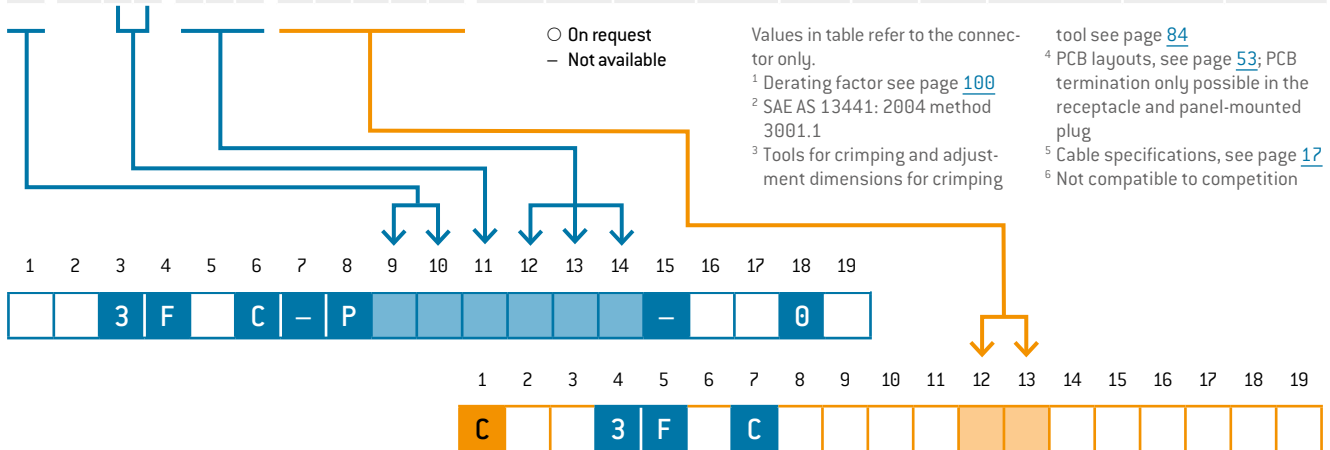

CONTACT INSERTS AND CABLE TYPES (SIZE 3)

Number of contacts	Contact type		Part number key	Cable type					Contact diameter mm	Single contact nominal current ¹ A	Clearance and creepage distance		Test voltage ² SAE kV RMS	Termination Ø mm	Termination cross section		View on termination area						
	Termination	Socket		Pin	Cable PVC unshielded ⁵	Cable PVC shielded ⁵	Cable PUJ unshielded ⁵	Cable PUJ shielded ⁵			Single wires ⁵	Contact to contact mm			Contact to housing mm	AWG	mm ²	Pin piece	Socket piece				
02	Solder	L	M	V T Ø	Z5	X5	V5	T5	Z5	3.0	32	1.7	1.4	1.80	2.7	12	4.00						
				V T Ø	Z4	X4	V4	T4	Z4														
04 ⁶	Solder	L	M	T S 9	Z3	X3	V3	T3	Z3	2.0	22.5	1.4	1.65	2.4	14	2.50							
				T S 9	Z2	X2	V2	T2	Z2														
				T 0 9	Z1	X1	V1	T1	Z1		17.5	1.9		1.4	1.85	16	1.50						
				T 0 9	Z0	X0	V0	T0	Z0									0.7	–	–			
07 ⁶	Solder	L	M	S N 9	YZ	WZ	UZ	SZ	YZ	1.6	14.5	1.5	1.80	1.4	18	1.00							
				S N 9	YY	WY	UY	SY	YY								–	–	–	–	–		
				S L 9	–	–	–	–	–		16	1.8		1.2	–	16 – 18	1.50 – 1.00						
				S 0 9	–	–	–	–	–									14.5	1.9	0.7	–	–	
08 ⁶	Solder	L	M	P N 9	YX	WX	UX	SX	YX	1.3	14	1.0	1.35	1.4	18	1.00							
				P N 9	YW	WW	UW	SW	YW								11	1.3	1.1	20	0.50		
				P H 9	YV	WV	UV	SV	YV		11	1.5		1.1	–	18 – 20	1.00 – 0.50						
				P H 9	YU	WU	UU	SU	YU									14	1.35	–	20 – 24	0.50 – 0.25	
				Crimp ³	N	P	–	P L 9	–		–	–		–	–	11	1.5	1.65	0.7	–	–		
								P H 9	–		–	–		–	–							–	–
PCB ⁴	Q	R	–	P 0 9	–	–	–	–	–	–	–	–	–	–	–	–							
				P 0 9	–	–	–	–	–	–	–	–	–	–	–	–	–	–					
10	Solder	L	M	P N Ø	ZR	XR	VR	TR	ZR	1.3	14	0.7	1.10	1.4	18	1.00							
				P N Ø	Z0	X0	V0	T0	Z0								11	1.2	0.9	1.35	1.1	20	0.50
				P H Ø	ZP	XP	VP	TP	ZP		11	1.4		0.9	–	–	–						
				P H Ø	Z0	X0	V0	T0	Z0									0.7	–	–			
12	Solder	L	M	P N Ø	ZR	XR	VR	TR	ZR	1.3	14	0.5	1.00	1.4	18	1.00							
				P N Ø	Z0	X0	V0	T0	Z0								11	1.0	0.9	1.35	1.1	20	0.50
				P H Ø	ZP	XP	VP	TP	ZP		11	1.2		0.9	–	–	–						
				P H Ø	Z0	X0	V0	T0	Z0									0.7	–	–			
14 ⁶	Solder	L	M	J H 9	ZD	XD	VD	TD	ZD	0.9	9	0.8	1.00	1.1	20	0.50							
				J H 9	ZC	XC	VC	TC	ZC								7.5	1.1	1.0	1.35	0.85	22	0.38
				J G 9	ZB	XB	VB	TB	ZB		9	1.4		1.0	–	20 – 24	0.50 – 0.25						
				J G 9	ZA	XA	VA	TA	ZA									0.7	–	–			
				Crimp ³	N	P	–	J H 9	–		–	–		–	–	7.5	1.4	1.35	0.7	–	–		
								J G 9	–		–	–		–	–							–	–
PCB ⁴	Q	R	–	J 0 9	–	–	–	–	–	–	–	–	–	–	–	–							
				J 0 9	–	–	–	–	–	–	–	–	–	–	–	–	–						

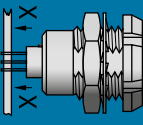
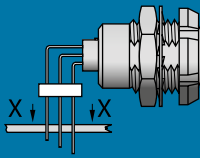
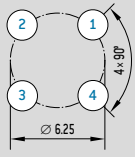
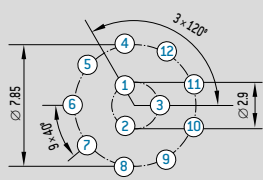
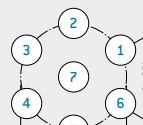
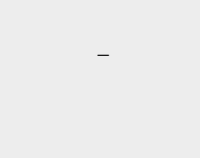
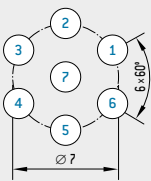
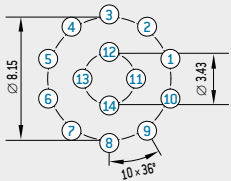
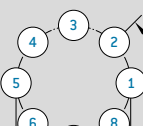

PCB LAYOUTS

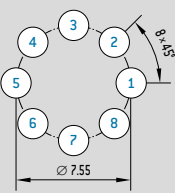
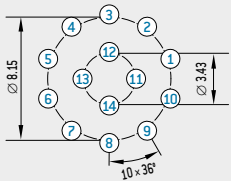
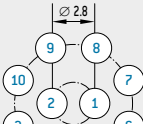
For PCB contacts [size 3].

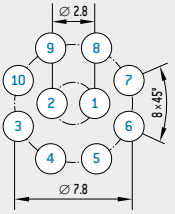
	Straight	90° right-angled		Straight	90° right-angled
4 contacts			Hole: 0.8 mm 	Hole: 0.8 mm 	on request
7 contacts			Hole: 0.8 mm 	Hole: 0.8 mm 	-
8 contacts			Hole: 0.8 mm 	Hole: 0.8 mm 	-
10 contacts			Hole: 0.8 mm 	on request	on request

All specifications are only valid for socket inserts.
 Pin inserts on request

CONTACT INSERTS AND CABLE TYPES (SIZE 3)

Number of contacts	Contact type		Part number key		Cable PVC unshielded ⁵	Cable PVC shielded ⁵	Cable PUJ unshielded ⁵	Cable PUJ shielded ⁵	Single wires ⁵	Contact diameter mm	Single contact nominal current ¹ A	Clearance and creepage distance		Test voltage ² SAE kV RMS	Termination Ø mm	Termination cross section		View on termination area										
	Termination	Socket	Pin	Part number key								Contact to contact mm	Contact to housing mm			AWG	mm ²	Pin piece	Socket piece									
15	Solder	L	M	J H 0	○ ○ ○ ○	○ ○ ○ ○	○ ○ ○ ○	○ ○ ○ ○	ZN	0.9	9	0.6	0.8	1.00	1.10	20	0.50											
				J H 0	○ ○ ○ ○	○ ○ ○ ○	○ ○ ○ ○	○ ○ ○ ○	ZM																			
		J G 0	○ ○ ○ ○	○ ○ ○ ○	○ ○ ○ ○	○ ○ ○ ○	ZZ																					
	Crimp ³	N	P	J H 0	– – – –	– – – –	– – – –	– – – –	–		9	1.2	–							–	–	–	20 – 24	0.50 – 0.25				
				J G 0	– – – –	– – – –	– – – –	– – – –	–		7.5	–	–							–	–	22 – 26	0.38 – 0.15					
				J 0 0	– – – –	– – – –	– – – –	– – – –	–		–	–	–							–	–	–	–	–				
PCB ⁴	Q	R	J 0 0	– – – –	– – – –	– – – –	– – – –	–	–	–	–	–	–	–	–	–	–	–										
			J 0 0	– – – –	– – – –	– – – –	– – – –	–	–	–	–	–	–	–	–	–	–	–	–									
			J 0 0	– – – –	– – – –	– – – –	– – – –	–	–	–	–	–	–	–	–	–	–	–	–									
16	Solder	L	M	M 0 0	ZF XF VF TF ZF	– – – –	– – – –	– – – –	–	12 x 0.7 4 x 1.6	6	0.7	0.7	0.90	0.65	26	0.15											
				M 0 0	ZE XE VE TE ZE	– – – –	– – – –	– – – –	–		16	0.7								1.80	14	2.50						
16	PCB ⁴	Q	R	M 0 0	– – – –	– – – –	– – – –	– – – –	–	–	–	1.0	1.5	–	–	–	–	–	–									
				M 0 0	– – – –	– – – –	– – – –	– – – –	–	–	–	–	–	–	–	–	–	–	–	–								
18	Solder	L	M	J H 0	○ XN ○ TN	○ ○ ○ ○	○ ○ ○ ○	○ ○ ○ ○	ZN	0.9	9	0.6	0.8	1.00	1.10	20	0.50											
				J H 0	○ XM ○ TM	○ ○ ○ ○	○ ○ ○ ○	○ ○ ○ ○	ZM																			
		J G 0	○ XZ ○ TZ	○ ○ ○ ○	○ ○ ○ ○	○ ○ ○ ○	ZZ																					
	Crimp ³	N	P	J H 0	– – – –	– – – –	– – – –	– – – –	–		9	1.2								–	–	–	–	–	–	–	–	
				J G 0	– – – –	– – – –	– – – –	– – – –	–		7.5	–								–	–	–	–	–	–	–	–	–
				J 0 0	– – – –	– – – –	– – – –	– – – –	–		–	–								–	–	–	–	–	–	–	–	–
PCB ⁴	Q	R	J 0 0	– – – –	– – – –	– – – –	– – – –	–	–	–	–	–	–	–	–	–	–	–	–									
			J 0 0	– – – –	– – – –	– – – –	– – – –	–	–	–	–	–	–	–	–	–	–	–	–	–								
			J 0 0	– – – –	– – – –	– – – –	– – – –	–	–	–	–	–	–	–	–	–	–	–	–	–								
20 ⁶	Solder	L	M	F G 9	Z9 X9 V9 T9 Z9	– – – –	– – – –	– – – –	–	0.7	7.5	0.7	0.8	1.00	0.85	22	0.38											
				F G 9	Z8 X8 V8 T8 Z8	– – – –	– – – –	– – – –	–		5	0.9								1.10	0.60	26	0.15					
		F D 9	Z7 X7 V7 T7 Z7	– – – –	– – – –	– – – –	–	–	–		–	–								–	–	–	–	–	–	–		
	Crimp ³	N	P	F G 9	– – – –	– – – –	– – – –	– – – –	–		7.5	0.8								–	–	–	–	–	–	–	–	
				F C 9	– – – –	– – – –	– – – –	– – – –	–		5	–								–	–	–	–	–	–	–	–	–
				F 0 9	– – – –	– – – –	– – – –	– – – –	–		–	–								–	–	–	–	–	–	–	–	–
PCB ⁴	Q	R	F 0 9	– – – –	– – – –	– – – –	– – – –	–	5	1.2	–	–	–	–	–	–	–	–	–									
			F 0 9	– – – –	– – – –	– – – –	– – – –	–	–	–	–	–	–	–	–	–	–	–	–	–								
			F 0 9	– – – –	– – – –	– – – –	– – – –	–	–	–	–	–	–	–	–	–	–	–	–	–								
22 ⁶	Solder	L	M	F G 9	Z9 X9 ○ T9 Z9	– – – –	– – – –	– – – –	–	0.7	7.5	0.7	0.7	1.00	0.85	22	0.38											
				F G 9	Z8 X8 ○ T8 Z8	– – – –	– – – –	– – – –	–		5	0.9								1.10	0.6	26	0.15					
		F D 9	Z7 X7 ○ T7 Z7	– – – –	– – – –	– – – –	–	–	–		–	–								–	–	–	–	–	–	–		
	Crimp ³	N	P	F G 9	– – – –	– – – –	– – – –	– – – –	–		7.5	0.5								–	–	–	–	–	–	–	–	
				F C 9	– – – –	– – – –	– – – –	– – – –	–		5	–								–	–	–	–	–	–	–	–	–
				F 0 9	– – – –	– – – –	– – – –	– – – –	–		–	–								–	–	–	–	–	–	–	–	–
PCB ⁴	Q	R	F 0 9	– – – –	– – – –	– – – –	– – – –	–	5	1.2	–	–	–	–	–	–	–	–	–									
			F 0 9	– – – –	– – – –	– – – –	– – – –	–	–	–	–	–	–	–	–	–	–	–	–	–								
			F 0 9	– – – –	– – – –	– – – –	– – – –	–	–	–	–	–	–	–	–	–	–	–	–	–								
24	Solder	L	M	F G 0	○ ○ ○ TX	○ ○ ○ ○	○ ○ ○ ○	○ ○ ○ ○	ZX	0.7	7.5	0.5	0.7	0.90	0.85	22	0.38											
				F G 0	○ ○ ○ TW	○ ○ ○ ○	○ ○ ○ ○	○ ○ ○ ○	ZW																			
	F D 0	○ ○ ○ ○	○ ○ ○ ○	○ ○ ○ ○	○ ○ ○ ○	ZV																						
	F D 0	○ ○ ○ ○	○ ○ ○ ○	○ ○ ○ ○	○ ○ ○ ○	ZU																						
PCB ⁴	Q	R	F 0 0	– – – –	– – – –	– – – –	– – – –	–	–	–	–	–	–	–	–	–	–	–	–									
			F 0 0	– – – –	– – – –	– – – –	– – – –	–	–	–	–	–	–	–	–	–	–	–	–	–								

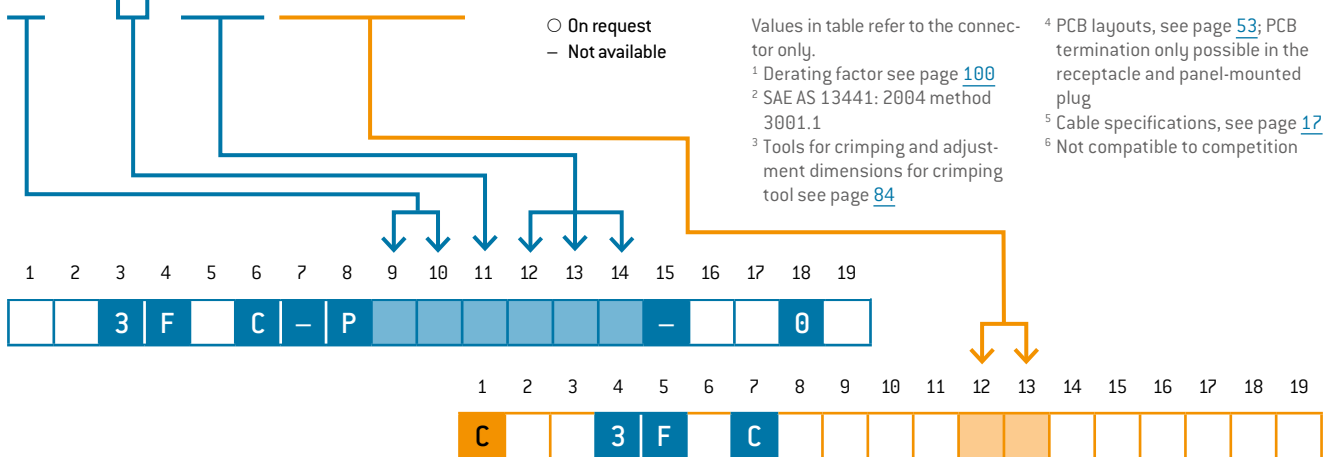

PCB LAYOUTS

For PCB contacts (size 3)

	Straight	90° right-angled
15 contacts	<p>Hole: 0.8 mm</p>	on request
16 contacts		on request
20 contacts	<p>Hole: 0.6 mm</p>	-
22 contacts	<p>Hole: 0.6 mm</p>	-
24 contacts	<p>Hole: 0.6 mm</p>	<p>Hole: 0.7 mm</p>

All specifications are only valid for socket inserts.
Pin inserts on request

CONTACT INSERTS AND CABLE TYPES (SIZE 3)

Number of contacts	Contact type			Part number key					Cable PVC unshielded ⁵	Cable PVC shielded ⁵	Cable PUJ unshielded ⁵	Cable PUJ shielded ⁵	Single wires ⁵	Contact diameter mm	Single contact nominal current ¹ A	Clearance and creepage distance		Test voltage ² SAE kV RMS	Termination diameter mm	Termination cross section		View on termination area				
	Termination	Socket	Pin	F	G	9	Contact to contact mm	Contact to housing mm								AWG	mm ²			Pin piece	Socket piece					
26 ⁶	Solder	L		F	G	9	Z9	X9	V9	T9	Z9	0.7	7.5	0.5	0.6	0.90	0.85	22	0.38							
			M	F	G	9	Z8	X8	V8	T8	Z8															
		L	F	D	9	Z7	X7	V7	T7	Z7																
	Crimp ³	N	P	F	G	9	–	–	–	–	–		–	7.5								0.3	0.90	–	22 – 26	0.38 – 0.15
				F	C	9	–	–	–	–	–		–	5									1.00	–	28 – 32	0.09 – 0.04
				PCB ⁴	Q	R	F	θ	9	–	–		–	–								–	5	1.0	0.5	–
27	Solder	L		F	G	θ	○	○	○	TX	ZX	0.7	7.5	0.5	0.90	0.85	22	0.38								
			M	F	G	θ	○	○	○	TW	ZW															
		L	F	D	θ	○	○	○	○	ZV	ZU															
	Crimp ³	N	P	F	G	θ	–	–	–	–	–		–	7.5							0.6	0.90	–	22 – 26	0.38 – 0.15	
				F	C	θ	–	–	–	–	–		–	5								1.00	–	28 – 32	0.09 – 0.04	
				PCB ⁴	Q	R	F	θ	θ	–	–		–	–							–	5	1.0	0.5	–	–

○ On request
– Not available

Values in table refer to the connector only.

¹ Derating factor see page 100

² SAE AS 13441: 2004 method 3001.1

³ Tools for crimping and adjustment dimensions for crimping tool see page 84

⁴ PCB layouts, see page 53; PCB termination only possible in the receptacle and panel-mounted plug

⁵ Cable specifications, see page 17

⁶ Not compatible to competition

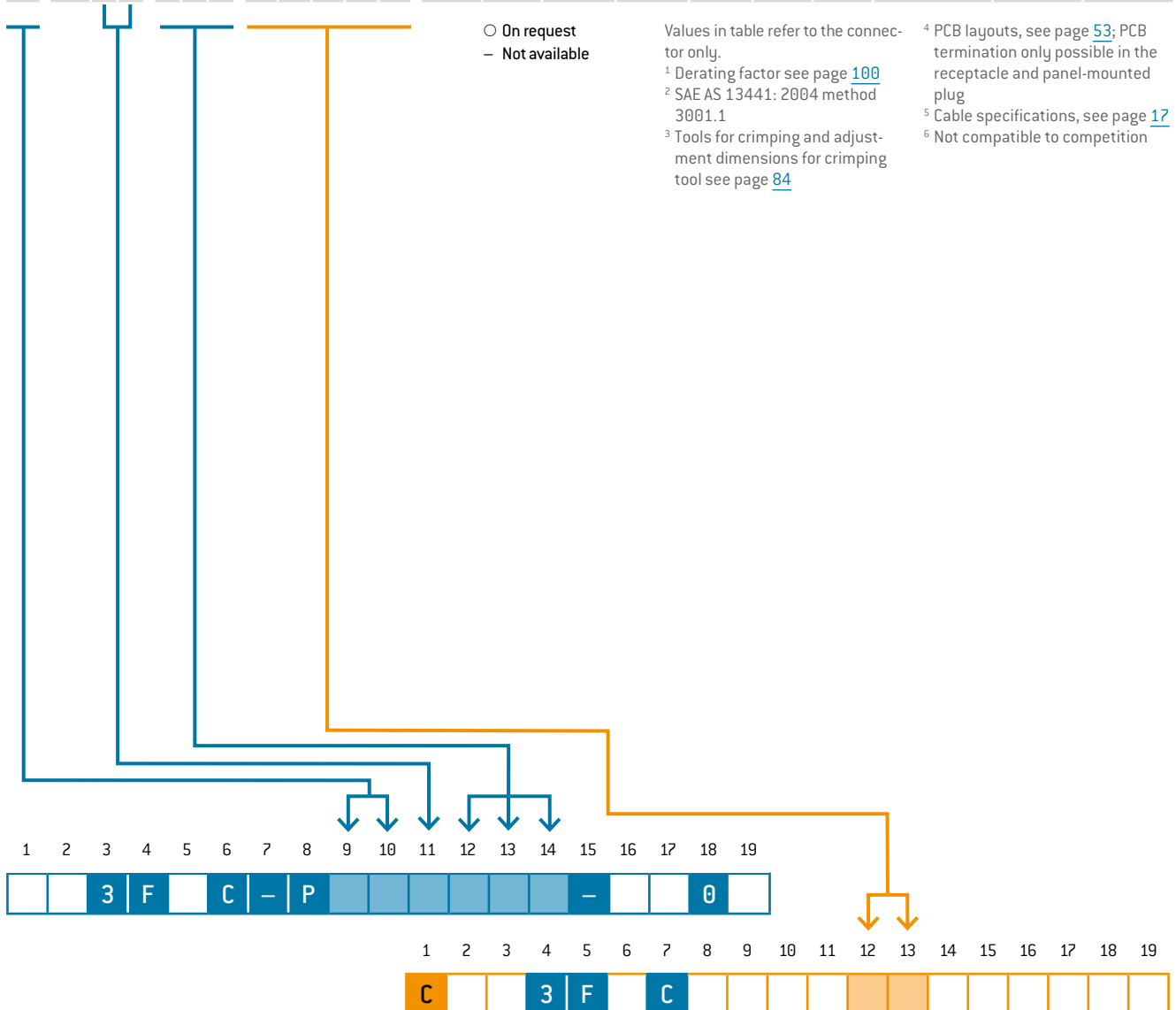

PCB LAYOUTS

For PCB contacts (size 3)

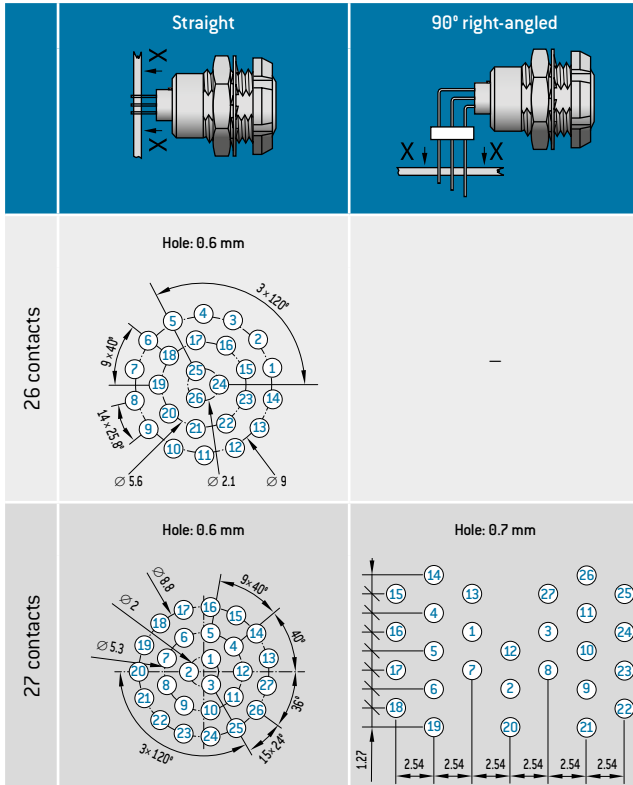

All specifications are only valid for socket inserts.

Pin inserts on request

RIGHT-ANGLED PCB CONTACTS IN THE RECEPTACLE

A

RIGHT-ANGLED PCB CONTACT

For style G5, G8 and GK.

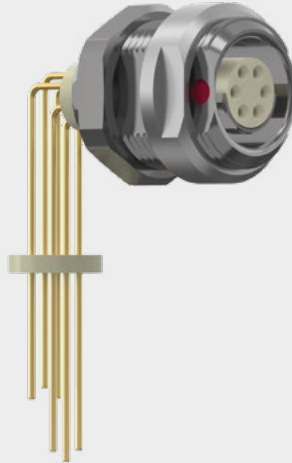

TECHNICAL DATA

- Pin version on request
- PCB layouts see from page [53](#)

Contact diameter	Termination diameter
mm	mm
0.5	0.5
0.7	0.6
0.9	0.6
1.3	0.8
1.6	0.8
2	0.8

Solder lug for the receptacle (on request)

1	2	3	4	5	6	7	8	9	10	11	12	13	14	15	16	17	18	19
			F		C	-	P					0	0	-		0	0	

CABLE COLLET SYSTEM

		Cable diameter mm	Size				
			0	1	1.5	2	3
1	5	> 1–1.5	○	●			
2	0	> 1.5–2	●	●			
2	5	> 2–2.5	●	●		○	
3	0	> 2.5–3	●	●	○	●	
3	5	> 3–3.5	●	●	●	●	●
4	0	> 3.5–4	●	●	●	●	●
4	5	> 4–4.5	●	●	●	●	●
5	0	> 4.5–5	●	●	●	●	●
5	5	> 5–5.5		●	●	●	●
6	0	> 5.5–6		●	●	●	●
6	5	> 6–6.5		●	●	●	●
7	0	> 6.5–7		●	●	●	●
7	5	> 7–7.5		○	●	●	●
8	0	> 7.5–8				●	●
8	5	> 8–8.5				●	●
9	0	> 8.5–9				●	●
9	5	> 9–9.5				○	●
0	1	> 9.5–10					●
0	2	> 10–10.5					●
0	3	> 10.5–11.5					○
0	0	without cable collet system (on request)					

● IP50 and IP68
○ IP50

APPLICATION: For all plugs and in-line receptacles

USE: Cable collet for strain relief; EMI ring for transmission of the shielding

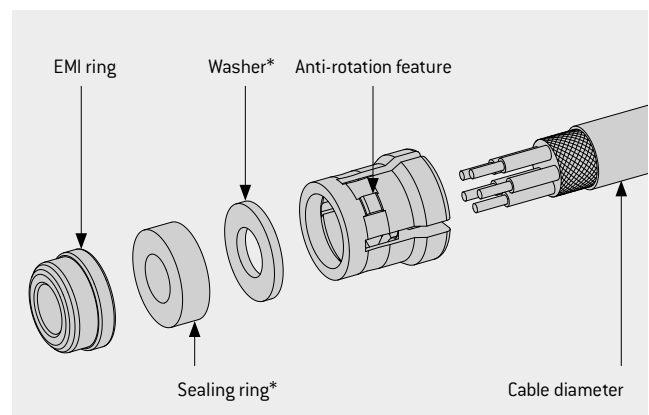

* Sealing ring and washer included with IP68 models only.

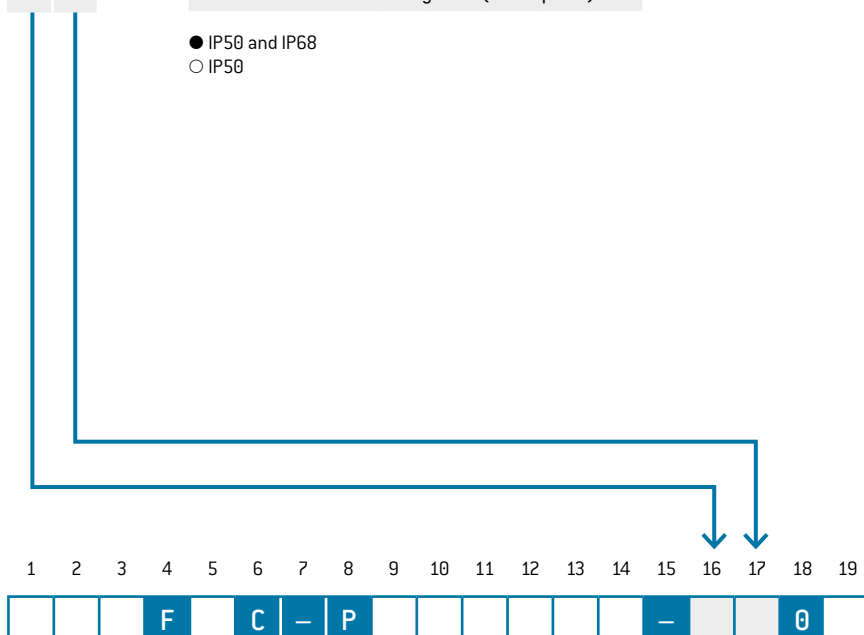

For assembly instructions please refer to our website: odu-connectors.com/downloads

COLOR CODING RINGS

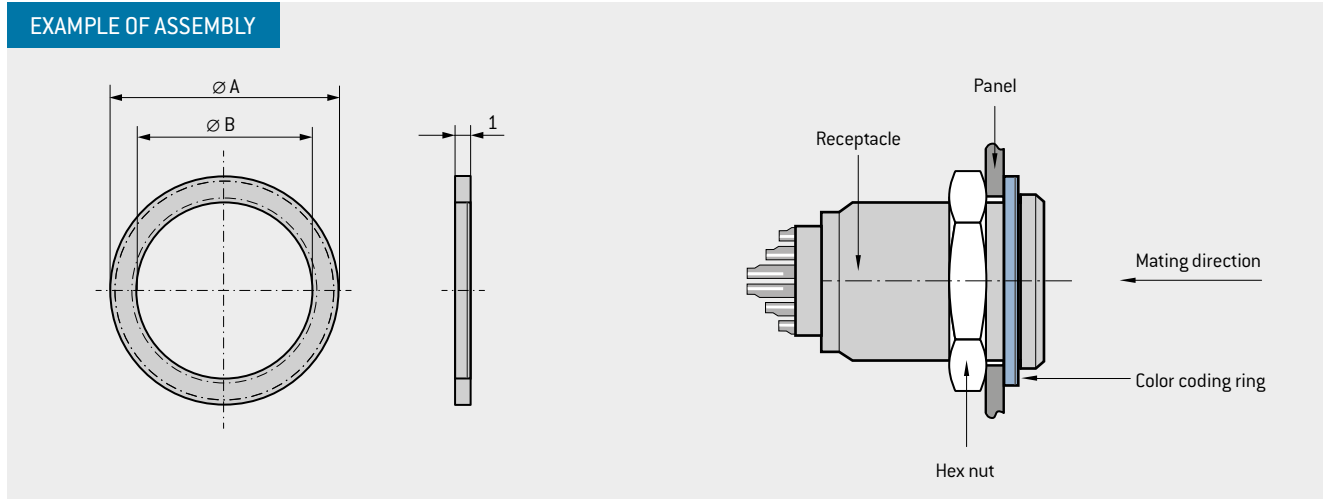

Material: Plastic PA66

SIZES

Thread	Part number	Ø A mm	Ø B mm
M 9	700.422.____.922.009	13.5	9.1
M 10	700.422.____.922.010	16.5	10.1
M 12	701.422.____.922.012	17	12.1
M 14	701.422.____.922.014	20	14.1
M 14	715.422.____.922.014	21	14.1
M 15	702.422.____.922.015	22	15.1
M 16	702.422.____.922.016	23	16.1
M 18	703.422.____.922.018	25	18.1
M 20	703.422.____.922.020	28	20.1

COLORS

Color code	Color	RAL no. ¹ (similar)
202	Red	3020
203	White	9010
204	Yellow	1016
205	Green	6029
206	Blue	5002
207	Grey	9007
208	Black	9005



HOW TO PLACE THE RIGHT ORDER:

This shows you how the part number of the color coding rings is composed. In the first step, select the size and note the part number. Put the color code and part number together depending on your choice of color (see example).

STEP 1:	Choose size	700.422.____.922.009
STEP 2:	Choose color	... 202 ...
STEP 3:	Completed part number	700.422.202.922.009

¹ The colors may differ slightly from the RAL number due to variances in raw materials.

DISTANCE RINGS FOR WALL-THICKNESS ADJUSTMENT

EXAMPLE OF ASSEMBLY FOR RECEPTACLE STYLE 2¹

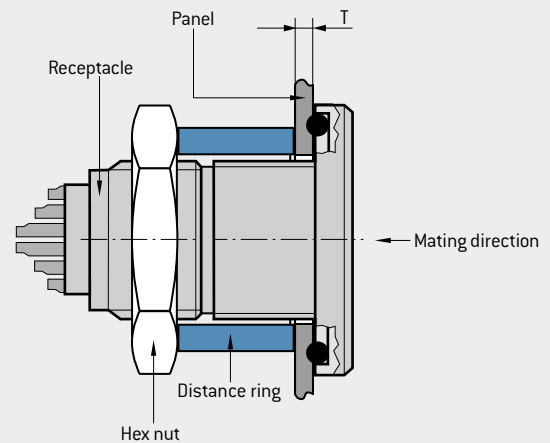
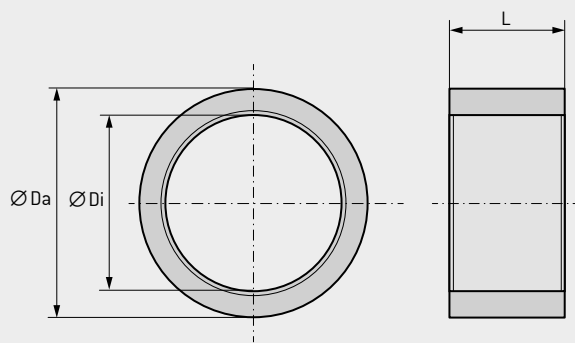

Size	Part number	Da mm	Di mm	L mm	T mm
0	700.123.102.304.000	13	10.3	7	1 – 6
1 / 1.5	701.123.102.304.000 ²	17	14.3	12	0.5 – 3
1 / 1.5	701.123.102.304.001 ³	17	14.3	6	3 – 9
2	702.123.102.304.000	21	16.3	8	1 – 8
3	703.123.102.304.000	25	20.3	11.5	0.5 – 7

¹ See page 44

² Wall thickness: 0.5 – 6 mm

³ Wall thickness: 6 – 16 mm

Material: CU alloy

Surface: nickel

PROTECTIVE COVERS

FOR PLUGS (IP50)

Size	Part number	A	Ø B	C	Ø D	Ø E
		mm	mm	mm	mm	mm
0	700.097.005.215._00	15.5	10	70	8	3.2
1	701.097.005.215._00	16.5	12	75	10	
1.5	715.097.005.215._00	15.5	13	80	11	
2	702.097.005.215._00	18	15	85	13	
3	703.097.005.215._00	20.5	18	100	16	

Material lanyard	
0	Polyamide lanyard with loop (Ø D)
1	Stainless steel lanyard with loop (Ø D)
2	Polyamide lanyard with solder lug (Ø E)
3	Stainless steel lanyard with solder lug (Ø E)

Surface matt chrome

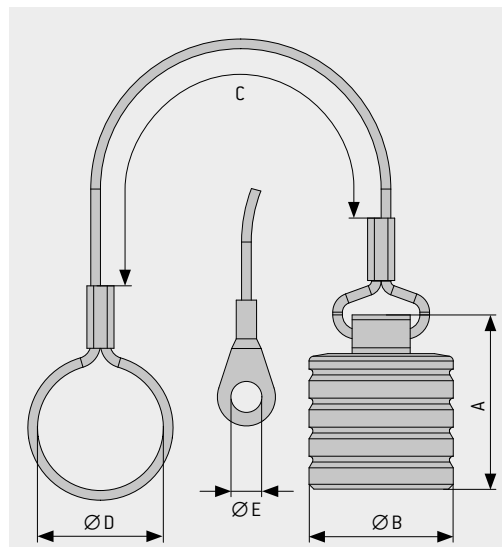

FOR PLUGS (IP68)

Size	Part number	A	Ø B	C	Ø D	Ø E
		mm	mm	mm	mm	mm
0	700.097.004.215._00	15.5	10.5	70	8	3.2
1	701.097.004.215._00	16.5	13	75	10	
1.5	715.097.004.215._00	16	13.5	80	11	
2	702.097.004.215._00	18.5	16	85	13	
3	703.097.004.215._00	21	19	100	16	

Material lanyard	
0	Polyamide lanyard with loop (Ø D)
1	Stainless steel lanyard with loop (Ø D)
2	Polyamide lanyard with solder lug (Ø E)
3	Stainless steel lanyard with solder lug (Ø E)

Surface matt chrome

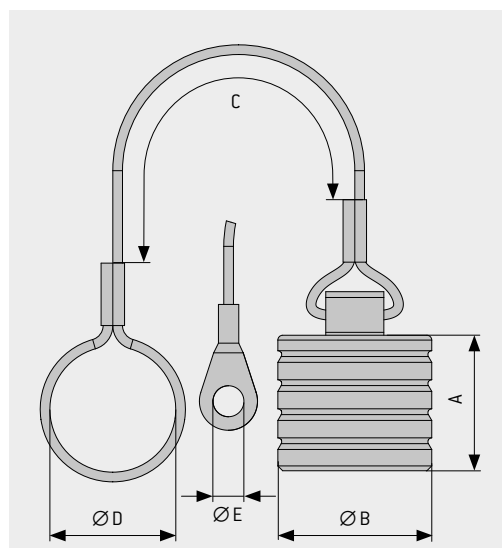

PROTECTIVE COVERS

FOR RECEPTACLES (IP50) AND IN-LINE RECEPTACLES

Size	Part number	A mm	Ø B mm	C mm	Ø D mm	Ø E mm
0	700.097.003.215._00	10.5	10	70	8	3.2
1	701.097.003.215._00	12.5	12	75	13	
1.5	715.097.003.215._00	13.3	13	80	11	
2	702.097.003.215._00	15	15	85	13	
3	703.097.003.215._00	16.6	18	100	16	

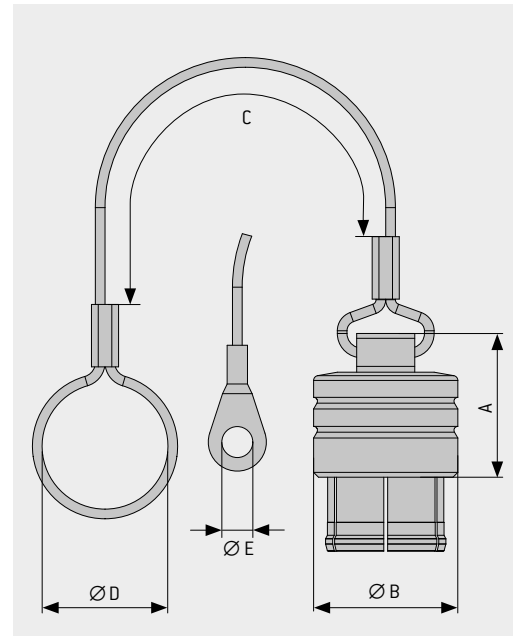

Material lanyard	
0	Polyamide lanyard with loop (Ø D)
1	Stainless steel lanyard with loop (Ø D)
2	Polyamide lanyard with solder lug (Ø E)
3	Stainless steel lanyard with solder lug (Ø E)

Surface matt chrome

FOR RECEPTACLE (IP68) AND IN-LINE RECEPTACLES

Size	Part number	A mm	Ø B mm	C mm	Ø D mm	Ø E mm
0	700.097.007.215._00	10	10	70	8	3.2
1	701.097.007.215._00	12	12	75	10	
1.5	715.097.007.215._00	13.3	13	80	11	
2	702.097.007.215._00	15	15	85	13	
3	703.097.007.215._00	17	18	100	16	

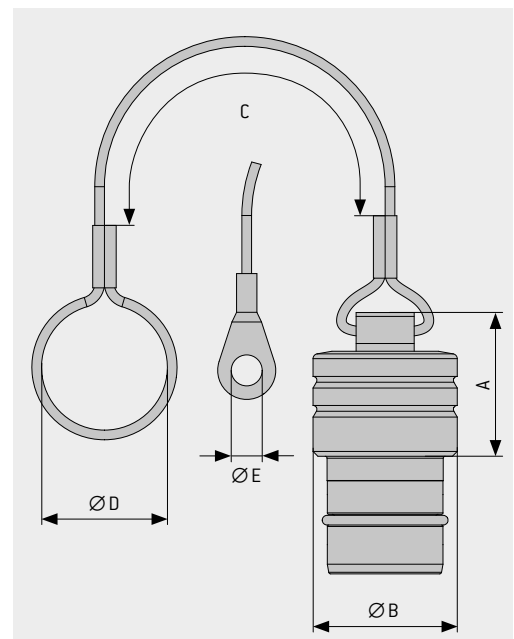

Material lanyard	
0	Polyamide lanyard with loop (Ø D)
1	Stainless steel lanyard with loop (Ø D)
2	Polyamide lanyard with solder lug (Ø E)
3	Stainless steel lanyard with solder lug (Ø E)

Surface matt chrome

TRANSPORTATION CAP

Compatible with all straight plugs

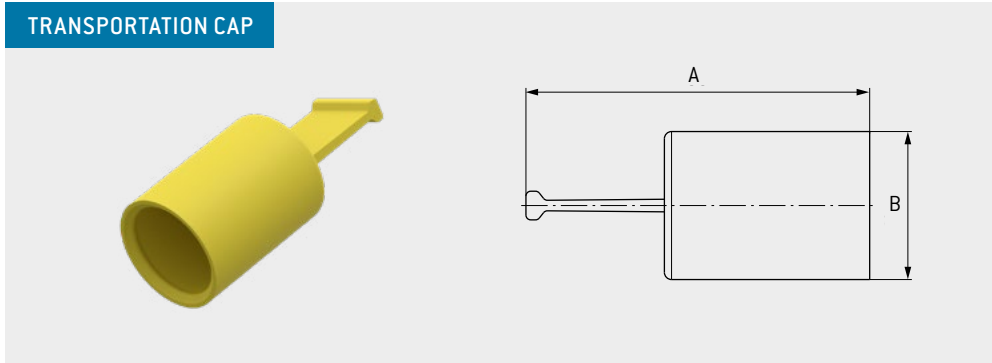

Size	Part number	Material	Color	Similar RAL systems		B	A
				Design	Classic		
0	922.000.002.000.072	TPE	Yellow	095 90 59	1016	9	20
1	922.000.002.000.073					11	
1.5	922.000.002.000.074					12	
2	922.000.002.000.076					14	
3	922.000.002.000.077					15	

BEND RELIEFS

Size	Part number	Dim. L mm	Cable jacket (∅ outside)	
			min.	max.
0	700.023.____.965.020	27	2	2.5
	700.023.____.965.025		2.5	3
	700.023.____.965.030		3	3.5
	700.023.____.965.035		3.5	4
	700.023.____.965.040		4	4.5
	700.023.____.965.045		4.5	5
1	701.023.____.965.025	30	2.5	3
	701.023.____.965.030		3	3.5
	701.023.____.965.035		3.5	4
	701.023.____.965.040		4	5
	701.023.____.965.050		5	6
	701.023.____.965.060		6	6.5
	701.023.____.965.070		6.5	7.5
1.5 ¹	715.023.____.965.030	36	3.0	3.5
	715.023.____.965.040		4.0	5.0
	715.023.____.965.050		5.0	6.0
	715.023.____.965.060		6.0	7.0
	715.023.____.965.070		7.0	8.0
2	702.023.____.965.025	36	2.5	3
	702.023.____.965.030		3	3.5
	702.023.____.965.035		3.5	4
	702.023.____.965.040		4	5
	702.023.____.965.050		5	6
	702.023.____.965.060		6	7
	702.023.____.965.070		7	8
	702.023.____.965.080		8	9
3	703.023.____.965.040	42	4	5
	703.023.____.965.050		5	6
	703.023.____.965.060		6	7
	703.023.____.965.070		7	8
	703.023.____.965.080		8	9
	703.023.____.965.090		9	10
	703.023.____.965.100		10	11
	703.023.____.965.110		11	12

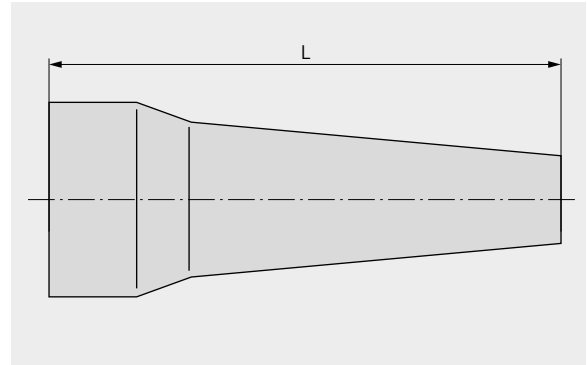

TEMPERATURE RANGE

Silicone: -50 °C up to +200 °C, short duration up to +230 °C
Autoclaveable

COLOR CODE BEND RELIEF

Color code	Color for silicon bend relief	RAL no. (similar)
0	Not applicable – standard backnut (Gray)	
202	A Red	3020
203	B White	9010
204	C Yellow	1016
205	D Green	6029
206	E Blue	5002
207	F Gray	7005
208	G Black	9005
	Color for overmolding	RAL no. (similar)
	B White	9010
	F Gray	7005
	G Black	9005

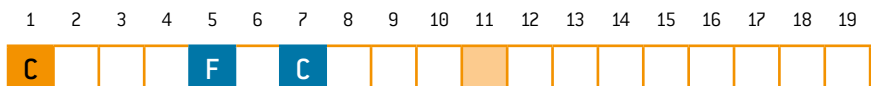

¹ Red, white, yellow and green on request only

BACK NUT FOR CABLE BEND RELIEFS

EXAMPLE OF ASSEMBLY

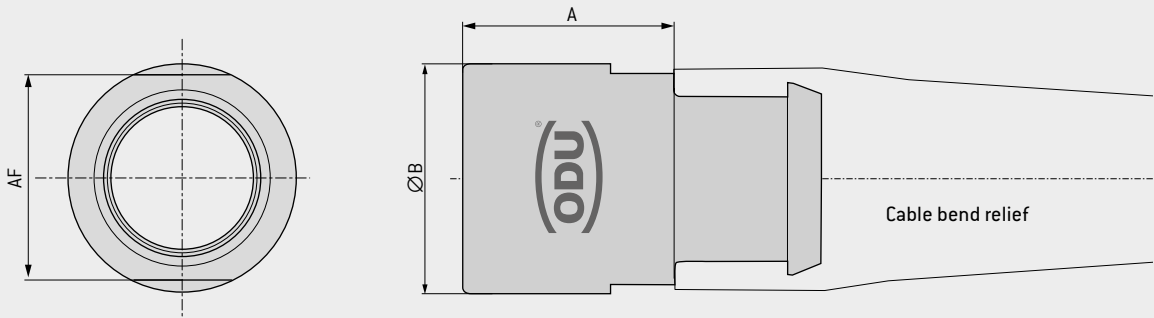

Size	Part number	A	Ø B	AF
		mm	mm	mm
0	700.022.117.3---.002	8	8.9	7
1	701.022.117.3---.002	10	10.9	10
1.5	715.022.117.3---.002	11	12.9	12
2	702.022.117.3---.002	11.5	13.9	13
3	703.022.117.3---.002	11.5	16.9	15

Surface		
15	Cu alloy / matt chrome plated	Standard
61	Cu alloy / tin-nickel plated	on request
04	Cu alloy / nickel	on request



LOCK WASHERS

EXAMPLE OF ASSEMBLY

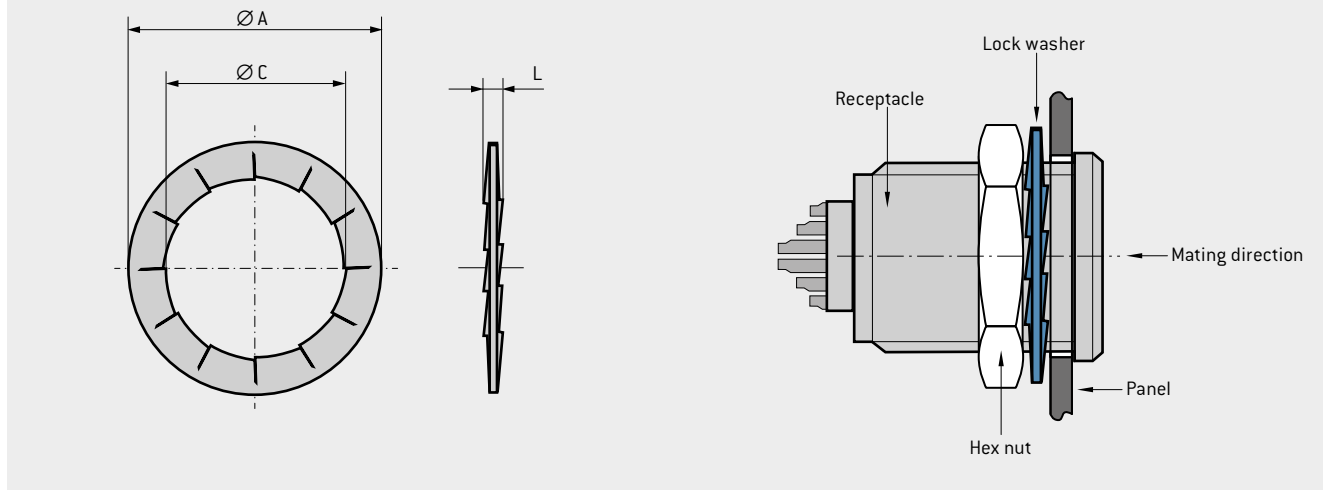

Thread	Part number	Ø A mm	Ø C mm	L mm
M9	945.000.001.000.046	12.5	9.1	1
M12	945.000.001.000.047	16	12.1	1.1
M14	945.000.001.000.070	19.5	14.2	1.1
M15	945.000.001.000.048	19.5	15.1	1.1
M16	945.000.001.000.072	21.5	16.1	1.1
M18	945.000.001.000.049	25	18.1	1.1
M20	945.000.001.000.121	25	20.1	1.1

Nickel plated surface

SOLDERING LUGS



EXAMPLE OF ASSEMBLY

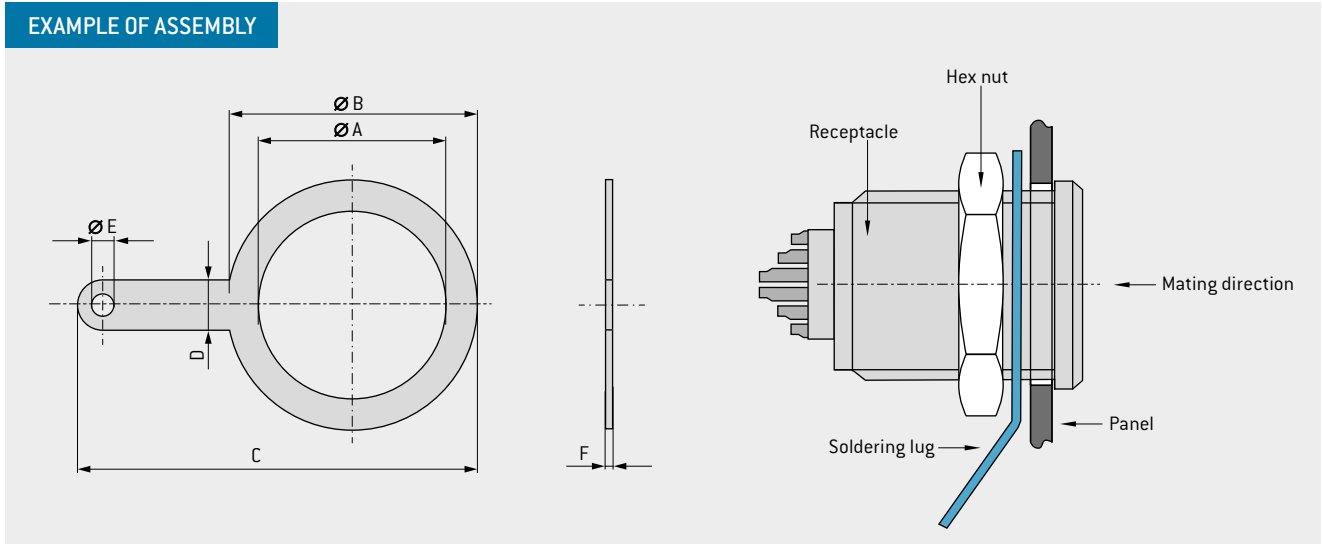

Thread	Part number	Ø A	Ø B	C	D	Ø E	F
		mm	mm	mm	mm	mm	mm
M9	700.140.246.301.000	9.7	13.2	21.6	4	1.6	0.5
M12	701.140.246.301.000	12.2	17	27.5	4	1.6	0.5
M14	715.140.246.301.000	14.1	18	27	4	2	0.5
M15	702.140.246.301.000	15.2	20	32	4	1.6	0.5
M16	721.140.246.301.000	16.2	20	32	4	1.6	0.5
M18	703.140.246.301.000	18.2	25	39	4	1.6	0.5
M20	722.140.246.301.000	20.2	25	39	4	1.6	0.5

Silver plated surface

FOR YOUR NOTES



ODU MINI-SNAP®

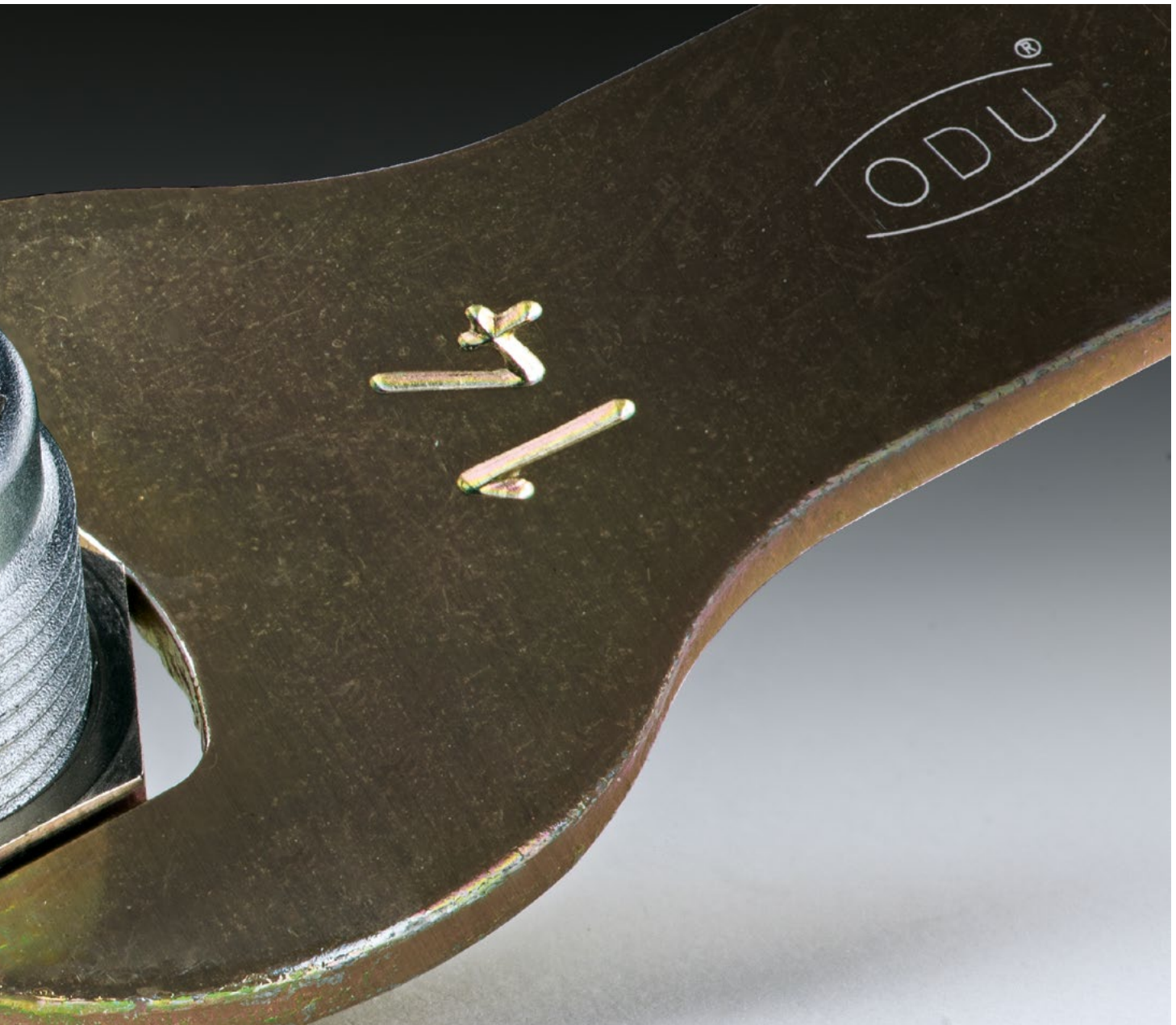

TOOLS

The following pages contain tools and wrenches to ensure that your ODU connectors function flawlessly.

CRIMPING TOOLS / ASSEMBLY TOOLS



PART NUMBER CRIMPING TOOL

080.000.051.000.000

Part number positioner
see table.

PROCESSING TOOLS FOR CRIMP CONTACTS: DIGITAL SETTING, MULTIPLE POSITIONER

Size	Number of contacts	Contact Ø mm	Termination cross-section		Adjustment dimension mm	Positioner	Positioning setting		Removal tool
			AWG	mm ²			Pin	Socket	
0	4	0.7	28 – 32	0.09 – 0.04	0.57	080.000.051.108.000	1	2	087.7CC.070.001.000
	4	0.7	22 – 26	0.38 – 0.15	0.67	080.000.051.108.000	1	2	087.7CC.070.001.000
1	6 – 8	0.7	28 – 32	0.09 – 0.04	0.57	080.000.051.108.000	3	4	087.7CC.070.001.000
	6 – 8	0.7	22 – 26	0.38 – 0.15	0.67	080.000.051.108.000	3	4	087.7CC.070.001.000
	4 – 5	0.9	22 – 26	0.38 – 0.15	0.67	080.000.051.108.000	5	6	087.7CC.090.001.000
	4 – 5	0.9	20 – 24	0.50 – 0.25	0.67	080.000.051.108.000	5	6	087.7CC.090.001.000
1.5	12	0.7	28 – 32	0.09 – 0.04	0.57	080.000.051.108.000	3	7	087.7CC.070.001.000
	12	0.7	22 – 26	0.38 – 0.15	0.67	080.000.051.108.000	3	7	087.7CC.070.001.000
2	16 – 19	0.7	28 – 32	0.09 – 0.04	0.57	080.000.051.110.000	1	2	087.7CC.070.001.000
	16 – 19	0.7	22 – 26	0.38 – 0.15	0.67	080.000.051.110.000	1	2	087.7CC.070.001.000
	12	0.7	28 – 32	0.09 – 0.04	0.57	080.000.051.106.000	1	2	087.7CC.070.001.000
	12	0.7	22 – 26	0.38 – 0.15	0.67	080.000.051.106.000	1	2	087.7CC.070.001.000
	10	0.9	22 – 26	0.38 – 0.15	0.67	080.000.051.106.000	3	4	087.7CC.090.001.000
	10	0.9	20 – 24	0.50 – 0.25	0.67	080.000.051.106.000	3	4	087.7CC.090.001.000
	5	1.3	20 – 24	0.50 – 0.25	0.67	080.000.051.110.000	3	4	087.7CC.130.001.000
	5	1.3	18 – 20	1 – 0.50	1.12	080.000.051.110.000	3	4	087.7CC.130.001.000
3	27	0.7	28 – 32	0.09 – 0.04	0.57	080.000.051.110.000	1	6	087.7CC.070.001.000
	27	0.7	22 – 26	0.38 – 0.15	0.67	080.000.051.110.000	1	6	087.7CC.070.001.000
	20 – 26	0.7	28 – 32	0.09 – 0.04	0.57	080.000.051.106.000	1	7	087.7CC.070.001.000
	20 – 26	0.7	22 – 26	0.38 – 0.15	0.67	080.000.051.106.000	1	7	087.7CC.070.001.000
	15 – 18	0.9	22 – 26	0.38 – 0.15	0.67	080.000.051.110.000	7	8	087.7CC.090.001.000
	15 – 18	0.9	20 – 24	0.50 – 0.25	0.67	080.000.051.110.000	7	8	087.7CC.090.001.000
	14	0.9	22 – 26	0.38 – 0.15	0.67	080.000.051.106.000	3	8	087.7CC.090.001.000
	14	0.9	20 – 24	0.50 – 0.25	0.67	080.000.051.106.000	3	8	087.7CC.090.001.000
	8	1.3	20 – 24	0.50 – 0.25	0.67	080.000.051.106.000	5	9	087.7CC.130.001.000
	8	1.3	18 – 20	1 – 0.50	1.12	080.000.051.106.000	5	9	087.7CC.130.001.000
	7	1.6	18 – 20	1 – 0.50	1.12	080.000.051.107.000	1	5	087.7CC.160.001.000
	7	1.6	18	1.50 – 1	1.12	080.000.051.107.000	1	5	087.7CC.160.001.000
	7	1.6	14 – 16	1.50 – 1	1.30	080.000.051.107.000	1	5	087.7CC.160.001.000

CRIMPING TOOLS / ASSEMBLY TOOLS



PART NUMBER CRIMPING TOOL

080.000.037.000.000

Part number positioner
see table.

PROCESSING TOOLS FOR CRIMP CONTACTS: WITH MIL APPROVAL, SINGLE POSITIONER

Size	Number of contacts	Contact Ø mm	Termination cross-section		Positioner		Selector number		Removal tool
			AWG	mm ²	Pin	Socket	Pin	Socket	
0	4	0.7	28 – 32	0.09 – 0.04	081.701.002.848.037	081.700.005.748.037	3	3	0827CC.070.001.000
	4	0.7	22 – 26	0.38 – 0.15	081.701.002.848.037	081.700.004.748.037	4	4	0827CC.070.001.000
1	6 – 8	0.7	28 – 32	0.09 – 0.04	081.702.001.848.037	081.701.002.748.037	3	3	0827CC.070.001.000
	6 – 8	0.7	22 – 26	0.38 – 0.15	081.702.001.848.037	081.701.002.748.037	4	4	0827CC.070.001.000
	4 – 5	0.9	22 – 26	0.38 – 0.15	081.701.002.849.037	081.701.002.749.037	4	4	0827CC.090.001.000
	4 – 5	0.9	20 – 24	0.50 – 0.25	081.701.003.849.037	081.701.003.749.037	7/6/5 ¹	7/6/5 ¹	0827CC.090.001.000
1.5	12	0.7	28 – 32	0.09 – 0.04	081.702.001.848.037	081.700.001.748.037	3	3	0827CC.070.001.000
	12	0.7	22 – 26	0.38 – 0.15	081.702.001.848.037	081.700.001.748.037	4	4	0827CC.070.001.000
2	12 – 19	0.7	28 – 32	0.09 – 0.04	081.702.001.848.037	081.702.001.748.037	3	3	0827CC.070.001.000
	12 – 19	0.7	22 – 26	0.38 – 0.15	081.702.001.848.037	081.702.001.748.037	4	4	0827CC.070.001.000
	10	0.9	22 – 26	0.38 – 0.15	081.701.002.849.037	081.702.003.749.037	4	4	0827CC.090.001.000
	10	0.9	20 – 24	0.5 – 0.25	081.701.003.849.037	081.702.002.749.037	7/6/5 ¹	7/6/5 ¹	0827CC.090.001.000
3	27	0.7	28 – 32	0.09 – 0.04	081.702.001.848.037	081.703.002.748.037	3	3	0827CC.070.001.000
	27	0.7	22 – 26	0.38 – 0.15	081.702.001.848.037	081.703.004.748.037	4	4	0827CC.070.001.000
	20-26	0.7	28 – 32	0.09 – 0.04	081.702.001.848.037	081.703.002.748.037	3	3	0827CC.070.001.000
	20-26	0.7	22 – 26	0.38 – 0.15	081.702.001.848.037	081.703.002.748.037	4	4	0827CC.070.001.000
	15-18	0.9	22 – 26	0.38 – 0.15	081.701.002.849.037	081.702.003.749.037	4	4	0827CC.090.001.000
	15-18	0.9	20 – 24	0.50 – 0.25	081.701.003.849.037	081.702.002.749.037	7/6/5 ¹	7/6/5 ¹	0827CC.090.001.000
	14	0.9	22 – 26	0.38 – 0.15	081.701.002.849.037	081.703.003.749.037	4	4	0827CC.090.001.000
	14	0.9	20 – 24	0.50 – 0.25	081.701.003.849.037	081.703.002.749.037	7/6/5 ¹	7/6/5 ¹	0827CC.090.001.000

¹ For AWG 20 position 7 / for AWG 22 position 6 / for AWG 24 position 5

SPANNER WRENCH

Part number	Dimensions in mm				
	AF	t	B	L	b
598.700.001.016.000	5	1.5	16	92	8
598.700.001.015.000	5.5	1.5	16	92	8
598.700.001.021.000	6	2	16	92	8
598.700.001.011.000	7	2	16	92	8
598.700.001.001.000	8	2	16	92	8
598.700.001.022.000	9	2	21.5	102	9
598.700.001.002.000	10	2	21.5	102	9
598.700.001.012.000	11	2	24.5	115	10
598.700.001.013.000	12	2.5	24.5	115	10
598.700.001.017.000	12.5	4	24.5	115	10
598.700.001.004.000	13	2.5	30.5	98	16.5
598.700.001.005.000	14	2.5	30.5	98	16.5
598.700.001.006.000	15	3	35.5	145	15
598.700.001.007.000	16	3	35.5	145	15
598.700.001.008.000	17	3	35.5	145	15
598.700.001.023.000	18	3	42	172	16
598.700.001.013.000	19	3	42	172	16
598.700.001.009.000	20	3	42	172	16
598.700.001.018.000	21	3	42	172	16
598.700.001.010.000	22	3	47	119	23.5
598.700.001.014.000	24	3	54	119	23.5
598.700.001.024.000	27	3	55	150	25
598.700.001.019.000	30	3	50	150	25
598.700.001.020.000	31	3	50	150	25

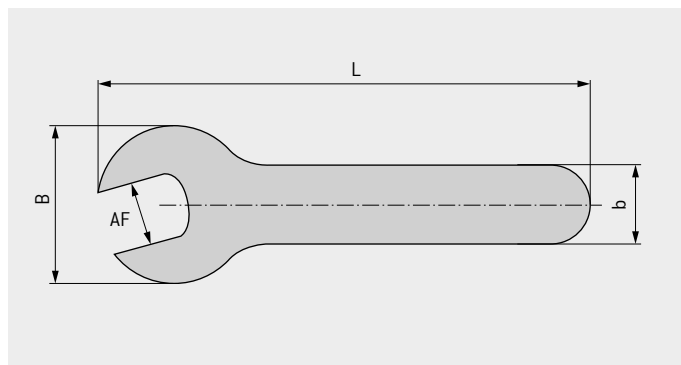

NUTDRIVER FOR SLOTTED MOUNTING NUT



Nutdriver	Thread	Length in mm L	Compatible with part number
700.098.002.000.000	M9 × 0.5	50	G80F.-
701.098.002.000.000	M14 × 1	60	G81F.- and G8AF.-
702.098.001.000.000	M16 × 1	60	G82F.-
703.098.001.000.000	M20 × 1	60	G83F.-

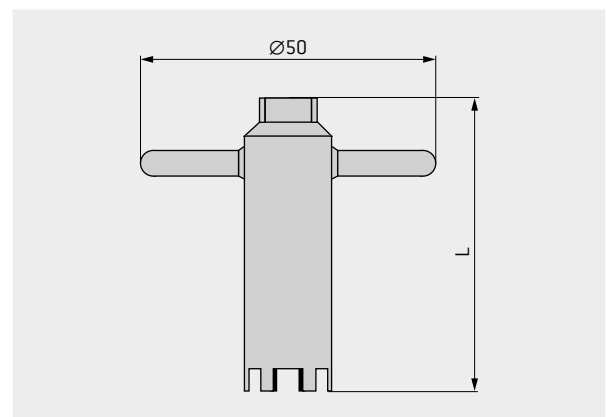

REMOVAL TOOLS FOR CRIMP-CLIP-CONTACTS

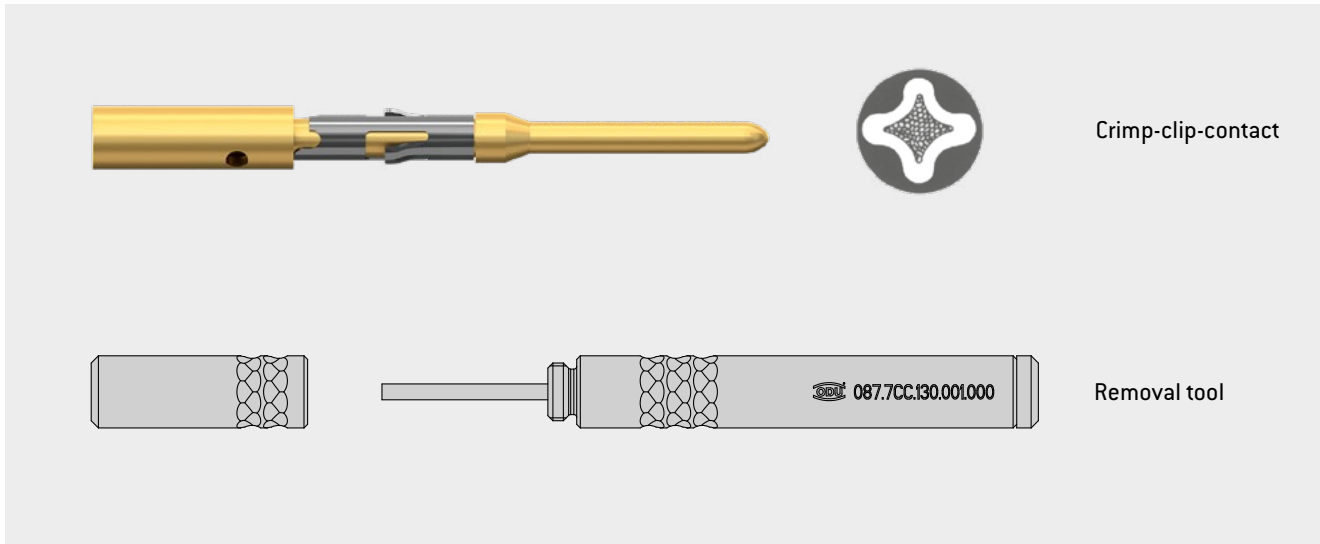

Part number	Contact Ø mm
087.7CC.070.001.000	0.7
087.7CC.090.001.000	0.9
087.7CC.130.001.000	1.3
087.7CC.160.001.000	1.6

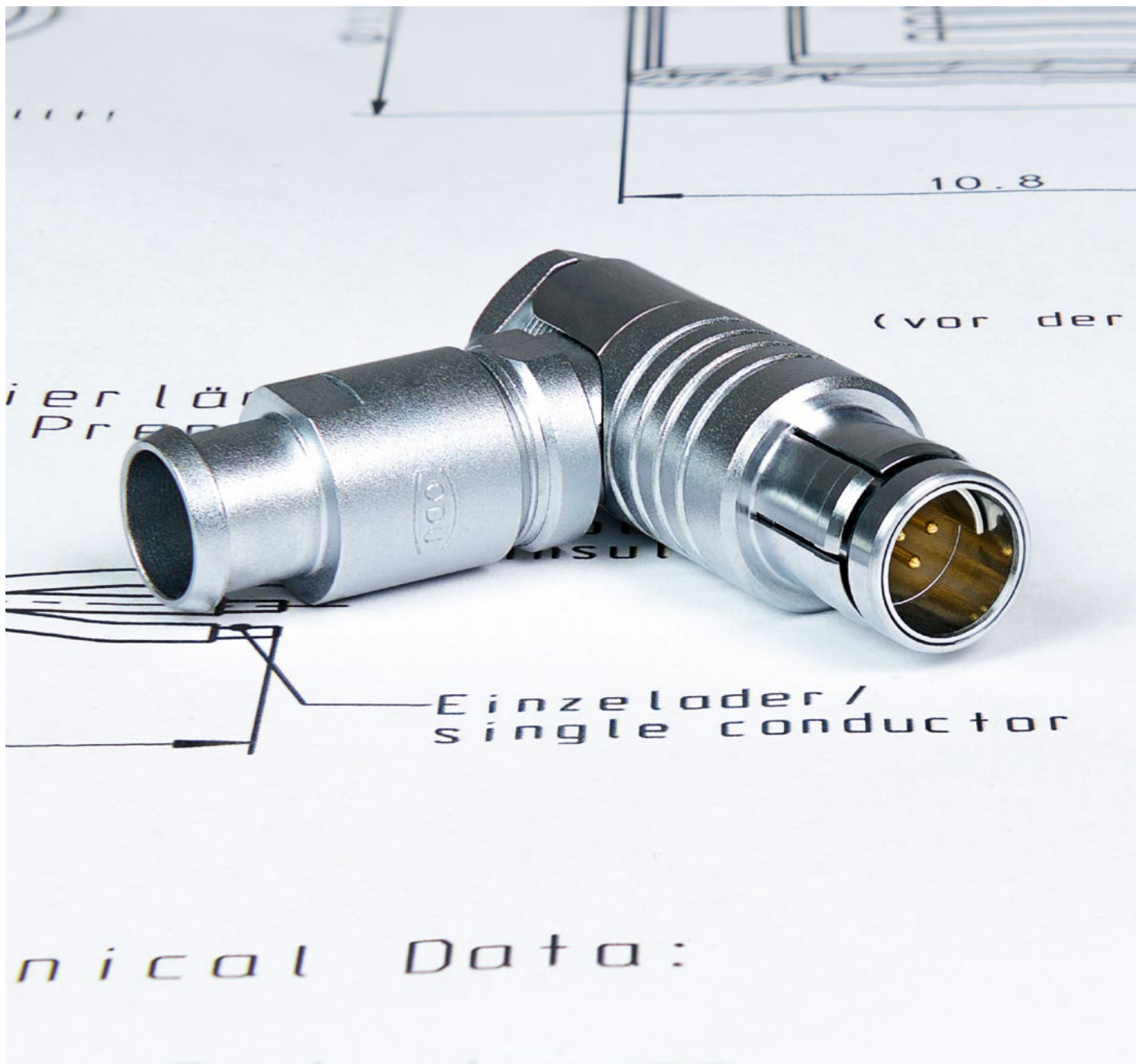

ODU MINI-SNAP®

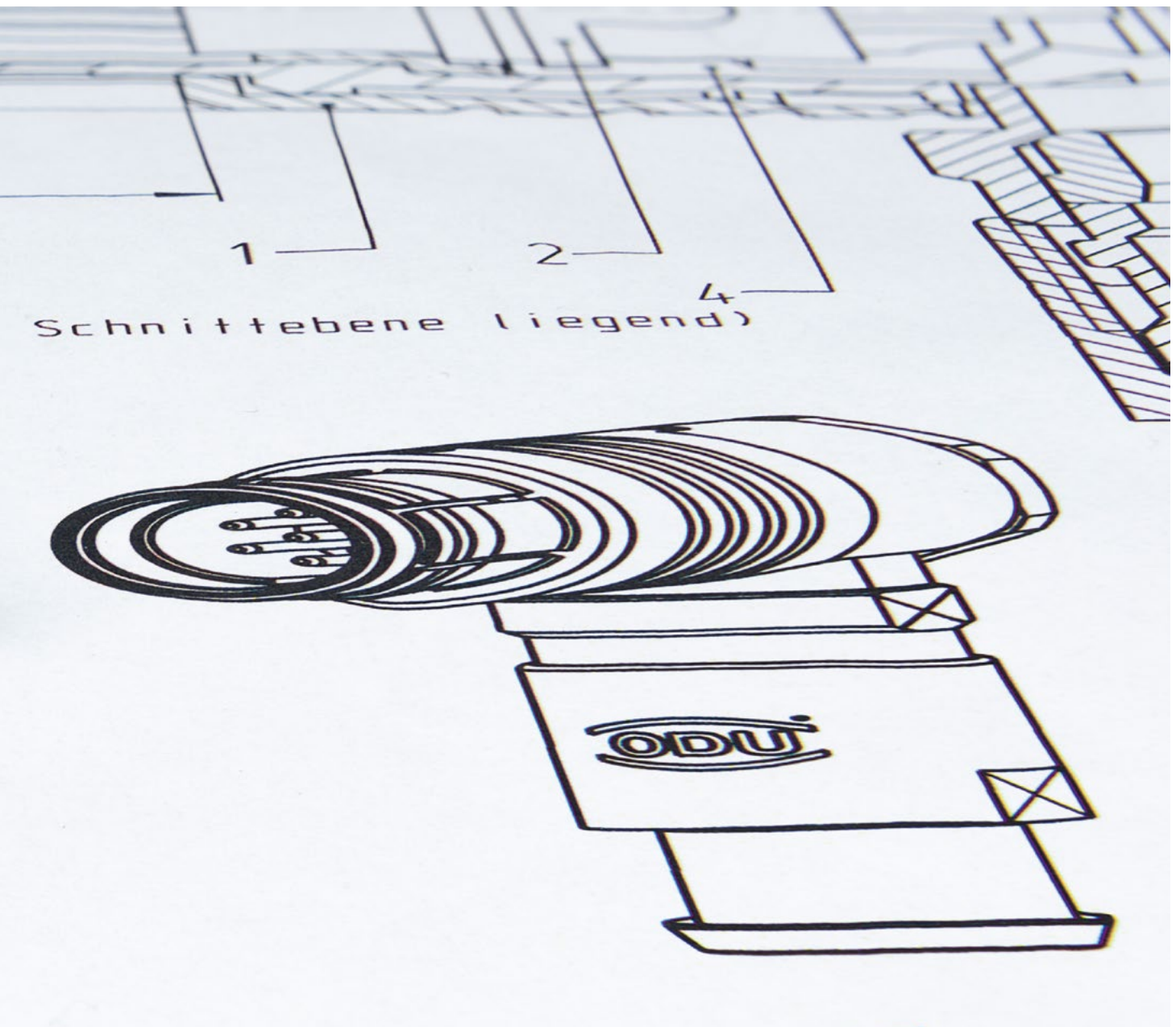

TECHNICAL INFORMATION

ODU connectors ensure perfect and reliable transmission of power, signal, data and other media in a wide variety of applications.

Further information can be found on the following pages.

INTERNATIONAL PROTECTION CLASSES

Acc. IEC 60529:1989 (VDE 0470-1:2014-09).



Code letters (International Protection)		First code number (Degrees of protection against access to hazardous parts respectively against solid foreign objects)		Second code number (Degrees of protection against water)		
IP		6		5		
Code number	Protection against access to hazardous parts / Protection against ingress of solid foreign objects			Code number	Protection against harmful effects due to the ingress of water	
0	No protection		No protection against contact / No protection against solid foreign objects	0	No protection against water	No protection against water
1	Protection against large foreign objects		Protection against contact with the back of the hand / Protection against solid foreign objects $\varnothing \geq 50$ mm	1	Protection against dripping water	Protection against vertically falling waterdrops
2	Protection against medium-sized foreign objects		Protection against contact with the fingers / Protection against solid foreign objects $\varnothing \geq 12.5$ mm	2	Protection against dripping water (tilted)	Protection against falling waterdrops when tilted (any angle up to 15° from the vertical)
3	Protection against small foreign objects		Protection against contact with tools / Protection against solid foreign objects $\varnothing \geq 2.5$ mm	3	Protection against spray water	Protection against spray water (any angle up to 60° from the vertical)
4	Protection against granular foreign objects		Protection against contact with a wire / Protection against solid foreign objects $\varnothing \geq 1.0$ mm	4	Protection against splashing water	Protection against splashing water from all directions
5	Dustproof		Protection against contact with a wire / Protection against uncontrolled ingress of dust	5	Protection against water jet	Protection against water jet from all directions
6	Dustproof		Protection against contact with a wire / Complete protection against ingress of dust	6	Protection against powerful water jet	Protection against powerful water jet from all directions
				7	Protection against the effects of temporary immersion in water	Protection against ingress of harmful quantities of water by temporary submersion into water
				8	Protection against the effects of continuous immersion in water	Protection against ingress of harmful quantities of water by continuous submersion into water
				9	Protection against high pressure water jet featuring high temperatures	Protection against water from all directions by high pressure and high temperatures



EXPLANATIONS AND DETAILS OF SAFETY REQUIREMENTS, INSPECTIONS, AND VOLTAGE DATA

GENERAL

All the technical information listed in this catalog and the data sheets has been determined by drawing on various standards. Unless otherwise stated, standard IEC 61984:2008 (VDE 0627:2009-11) "Connectors – Safety requirements and tests" has been used to dimension and determine the values provided.

This international standard applies to connectors (with rated voltages of 50 V to 1,000 V alternating and direct, and rated currents of up to 125 A per contact) which either have no type specification or which have a type specification whose safety requirements refer to this standard. The standard can be used as a guide for connectors with rated voltages up to 50 V. In cases such as this, IEC 60664-1:2007 must be consulted when dimensioning the clearance and creepage distances. This standard can also serve as a guide for connectors with rated currents higher than 125 A per pole.

All the connectors shown here are connectors without breaking capacity (COC) according to IEC 61984:2008 (VDE 0627:2009-11).

All of the voltage data listed in this catalog applies when ODU MINI-SNAP® connectors and inserts are being used properly. Customer-specific attachments, which could reduce the clearance and creepage distances, have not been taken into account here.

The clearance and creepage distances are determined on the bases specified in IEC 60664-1:2007 (VDE 0110-1:2008-01).

The most important influence variables and the electrical parameters harmonized with these will be explained in more detail in the following. We would be happy to assist you with any further questions. The texts and tables given here are excerpts from the indicated standards. As a rule, product committees lay down application-specific safety requirements for various fields of use; these requirements also regulate the insulation coordination and inspection of connectors.

In such cases, the "product standards" which apply to your applications take precedence and must be observed instead of the "basic safety standards" stated here. However, since this catalog and the technical data sheets cannot take all product standards into consideration, we have restricted ourselves to the following standard in terms of voltage data:

IEC 60664-1:2007 (VDE 0110-1:2008-01) "INSULATION COORDINATION FOR EQUIPMENT WITHIN LOW-VOLTAGE SYSTEMS"

This is what is known as a **basic safety standard**, which regulates the minimum requirements for dimensioning clearance and creepage distances, as well as their inspection. The standard applies to equipment used up to an altitude of 2,000 m above sea level and with a rated alternating voltage of up to 1,000 V and a nominal frequency of up to 30 kHz or a rated direct voltage of up to 1,500 V. The correction factors stated in the standard must be taken into account for applications at altitudes over 2,000 m above sea level.

The standard applies in those cases where corresponding product standards do not define any values for clearance and creepage distances, nor lay down any requirements for solid insulation, or where no product standards are even available.

The following general specifications have been defined for dimensioning:

- **Isolation** between electrical circuits (functional insulation between the contacts) or between an electrical circuit and local ground (contact with grounded connector components) has been dimensioned as **basic insulation**. If "double insulation" or "reinforced insulation" is required in your application, the voltage data provided will no longer apply; insulating clearances will need to be extended. The standard describes the procedure to follow in this case.
- Condition A is always used for the inhomogeneous field when dimensioning the clearance distances used.
- The inspections prescribed for solid insulation and for clearance distances (if necessary) are conducted as alternating voltage inspections according to Table F.5.
- The clearance and creepage distances are determined on the bases specified in this standard.

OPERATING VOLTAGE / RATED VOLTAGE / NOMINAL VOLTAGE

The **rated voltage** is the voltage which the manufacturer specifies for a connector and which the operating and performance features relate to. Some standards use the term "rated voltage" or "working voltage" instead of "operating voltage".

EXPLANATIONS AND DETAILS OF SAFETY REQUIREMENTS, INSPECTIONS, AND VOLTAGE DATA



In these explanations, the term “nominal voltage” is used for the value of the issued voltage indicated by the power supply company (PSC) or by the manufacturer of the voltage source for classification of the overvoltage category.

Equipment may have more than one value or one range for rated voltage (see Table F.4 in IEC 60664-1:2007 [VDE 0110-1:2008-01]).

RATED SURGE VOLTAGE

Value of an impulse withstand voltage that is indicated by the manufacturer for equipment or a part thereof, and which indicates the defined endurance of its insulation against transient (brief, duration of a few milliseconds) overvoltages. The impulse withstand voltage is the highest value of the surge voltage of a defined form and polarity which will not result in the dielectric breakdown of the insulation under defined conditions.

Depending upon the indicated pollution degree, the rated surge voltage depends upon the clearance distance between the individual contacts or contacts to the housing (see Table F.2 in IEC 60664-1:2007 [VDE 0110-1:2008-01]). You can determine the corresponding rated surge voltages for our connectors in this way if you need to take account of loads with transient overvoltages in your application.

According to this standard, the minimum clearance distances for equipment not connected directly to the low voltage mains should be measured according to the possible continuous voltages, the temporary overvoltages, or periodic peak voltages (see Table F.7 in IEC 60664-1:2007 [VDE 0110-1:2008-01]).

If a “periodic peak voltage” is present for a long time over the service life (more than approximately 60 minutes), this is not an overvoltage as regards insulation dimensioning under the terms of the standard, but must be considered a continuous voltage instead. In such cases, the “periodic peak voltage” must be used as the operating voltage.

DEGREE OF POLLUTION

Potentially occurring pollution combined with moisture can influence the insulation capacity on the surface of the connector. In order to define various rating parameters, a pollution degree

must be selected for the equipment according to the criteria listed below.

In the case of a connector with a degree of protection of minimum IP54 IEC 60529:1989 [VDE 0470-1:2014-09], the insulating parts may be measured enclosed according to the standard for a low pollution degree. This also applies for mated connectors for which enclosure is ensured by the connector housing and which are only disconnected for inspection and maintenance purposes.

Pollution degree 1

No or only dry, non-conductive pollution is present. The pollution has no influence. For example, computer systems and measuring instruments in clean, dry, or air-conditioned rooms.

Pollution degree 2

(= standard, if no specific pollution degree is indicated)

Only non-conductive pollution is present. However, temporary conductivity due to condensation must be anticipated. For example, devices in laboratories, residential, sales, and other business areas.

Pollution degree 3

Conductive pollution is present or dry, non-conductive pollution that will become conductive because condensation is expected. For example, devices in industrial, commercial, and agricultural operations, unheated storage areas, and workshops.

Pollution degree 4

Permanent conductivity is present, caused by conductive dust, rain, or moisture. For example, devices in the open air or outdoor facilities and construction machinery. Operating voltage [VDE: rated voltage]: Value of a voltage that is specified by the manufacturer for a component, device, or item of equipment and relates to the operating and performance features.

Depending upon the indicated pollution degree, the rated voltage is dependent upon the insulating material group of the connector and the respective creepage distances between the individual contacts.



EXPLANATIONS AND DETAILS OF SAFETY REQUIREMENTS, INSPECTIONS, AND VOLTAGE DATA

CLEARANCE DISTANCE

The shortest distance by air between two conductive parts (according to IEC 60664-01:2007).

CREEPAGE DISTANCE

The shortest distance between two conductive parts along the surface of a solid insulation material (according to IEC 60664-

01:2007). This factors in all elevations and recesses in the insulator, as long as defined minimum dimensions are on hand.

TEST VOLTAGES

The test voltage which a connector or a corresponding cable assembly can withstand under defined conditions without dielectric breakdown or flashover.

IEC 60664-1:2007 (VDE 0110-1:2008-01): Table F.5 – test voltages for testing clearance distances at different altitudes (the voltage levels are valid only to verify the clearance distances)

Rated surge voltage û kV	Test surge voltage at sea level û kV	Test surge voltage at 200 m elevation û kV	Test surge voltage at 500 m elevation û kV
0.330	0.357	0.355	0.350
0.500	0.541	0.537	0.531
0.800	0.934	0.920	0.899
1.500	1.751	1.725	1.685
2.500	2.920	2.874	2.808
4.000	4.923	4.874	4.675
6.000	7.385	7.236	7.013
8.000	9.847	9.648	9.350
12.000	14.770	14.471	14.025

OPERATING VOLTAGE (RATED VOLTAGE)

All shown connectors are rated to safety extra low voltage (SELV) less than 50 V AC / 75 V DC, according to IEC 61140:2016 (VDE 0140-1:2016), protection against electrical shock – common aspects for installation and equipment. In case that other standards rule a specific use of the connector, the application specific safety criteria shall be considered first. In this context, lower voltage ratings may be valid. If a higher operating voltage

is needed, please refer to chapter VOLTAGE DATA ACCORDING TO “MIL”, page [94](#).

All shown connectors are connectors without breaking capacity (COC) according to IEC 61984:2008 (VDE 0627:2009-11). For cable assemblies, please see operating voltage rating page [17](#).

VOLTAGE DATA ACCORDING TO “MIL”



Acc. SAE AS 13441:2004 method 3001.1

The values specified in the catalog correspond to SAE AS 13441:2004 method 3001.1. The table values were determined according to EIA-364-20F:2019-02. The inserts were tested while mated, and the test current was applied to the pin insert.

75 % of the dielectric withstanding voltage is used for the further calculation. The operating voltage is 1/3 of this value.

All tests were conducted at normal indoor climate and apply up to an altitude of 2,000 m. If there are any deviations, the reduction factors are to be factored in according to the applicable standards.

Test voltage: Dielectric withstanding voltage $\times 0.75$

Operating voltage: Dielectric withstanding voltage $\times 0.75 \times 0.33$

CAUTION:

For operating voltages above 50 V AC / 120 V DC (SELV), life is in danger!

Subsequently explained procedure according SAE AS 13441:2004 method 3001.1 does not consider protection against electric shock. Suitable precautions (protective measures) such as touch protection, protective insulation, protective separation, protective earth conductor etc. must be taken.

In the case that other standards rule a specific use of the connector, the application specific safety criteria shall be considered first. This must be evaluated in the frame of equipment engineering.

For any advise on how to choose the proper connector please consult us and indicate the safety standard which your product has to meet.

Test voltage: Dielectric withstanding voltage $\times 0.75$

Operating voltage: Dielectric withstanding voltage $\times 0.75 \times 0.33$

For cable assemblies, please see operating voltage rating page [17](#).

PRINCIPLE OF WATERTIGHTNESS SEALING PRINCIPLE

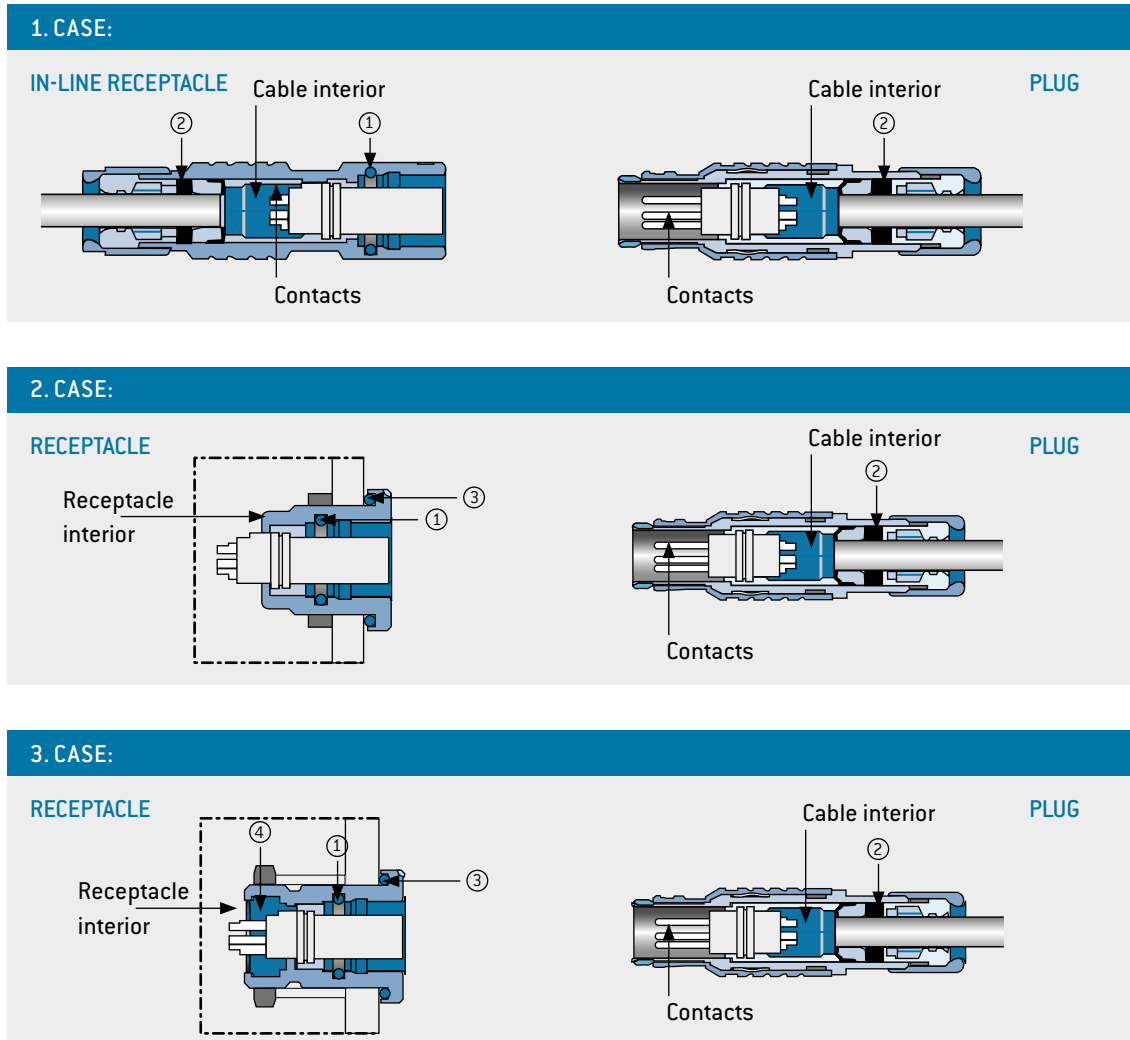

All IP68 submersible ODU MINI-SNAP® connectors have a rated water depth of 2 m (0.2 bar) for 24 hours in accordance with IEC 60529:2013 (VDE 0470-1:2014). A watertight connector requires a sealing in a cable collet system.

The sealing must fit over the cable precisely. The cable jacket must be smooth, cylindrical and free of grooves.

The connector should be encapsulated to make it watertight when not mated.

The protection class in mated condition is only applicable, when the individual connectors have the same protection class.

PROTECTION AGAINST WATER BY THE FOLLOWING SEALINGS¹

Case	Termination	Mated		Unmated	
		Tight	Position	Tight	Position
1	Cable interior	Yes	① ②	No	
2	Receptacle interior	Yes	① ② ③	No	
3	Receptacle interior	Yes	① ② ③	Yes	③ ④

- ① O-ring ② Gasket² ③ O-ring ④ Potting

¹ The following applies to the contacts: the contacts are protected in cases 1, 2 and 3 when mated. When not mated, the contacts are only protected by a protective cover (see from page 24) which must be removed before mating.

² The cable seal with elastic disks requires coordination with the cable. Decisive factors: Diameter tolerance, roundness, cable structure, cable jacket hardness.

HOUSING MATERIALS / SURFACES



Component	Material designation	Surface
Connector housing Back nut Round nut	Cu alloy	Cr
Cable collet EMI ring Half-shells Lock washer Nut Retainer ring	Cu alloy	Ni
Contact	Cu alloy	Au

ODU MINI-SNAP® connector housings are made of brass, nickel plated and then matt chrome plated. Nickel and tin-nickel plated connector plug housings are available upon request as special materials (not autoclavable).
The internal parts are made of nickel plated brass.

INSULATOR MATERIALS (ROHS 2011/65/EU COMPLIANT)

	Norm	Unit	PEEK
Dielectric strength	IEC 60243-1:2013	KV/mm	19
Operation temperature	ASTM D-149:2020	°C	-50 / +250
Flammability rating	UL 94:2013	-	V-0
Comparative tracking index CTI	IEC 60112:2009 (VDE 0303-11:2010-05)		175
Water absorption	ASTM D 570:1998 / ISO 62:2008-02	%	0.1
Sterilization (autoclaving)	DIN EN 13060:2019-02	Quantity	> 200
Insulation resistance	IEC 60512-3-1:2002 (DIN EN 60512-3-1:2003-01)	Ω	> 1 × 10 ¹² Ω

All values in new condition

For cable specifications see page [17](#)

TERMINATION TECHNOLOGIES



Insulators with pin contacts fit into the receptacle (or in-line receptacle) as well as into the plug. The same applies to insulators with socket contacts. In general, insulators with socket contacts are installed in the live part (to provide protection from accidental touch).

The means of mounting the contacts in the insulator is important on account of the termination technologies. Termination technologies for ODU MINI-SNAP® connectors include: soldering, crimping and PCB.

SOLDER TERMINATION



CRIMP-CLIP-CONTACT FOR PEEK INSULATOR



PRINT TERMINATION



TERMINATION TECHNOLOGIES FOR TURNED CONTACTS

Solder termination

The contacts are mounted in the insulator before the single conductors are assembled.

An insulator with pre-installed contacts is referred to as a contact insert.

For cable assemblies only solder contacts are used.

Crimp termination

Here, the individual contact is connected to the individual wires via deformation in the termination area. Then the contacts are individually installed in the insulator. Accordingly, insulators and individual contacts – and not complete contact inserts – are supplied for the crimp termination. The contact processing for the production of connecting cables via crimping creates a secure, durable and corrosion-free contact. Cold compaction (crimping) compresses the conductor and contact material to the press points so as to form a gas-tight connection with tensile strength to fit the conductor material. 8-point deformation is generally used for turned crimp contacts.

PCB termination

This is only used in the receptacle or the panel mounted plug in if the receptacle or the panel mounted plug is to be mounted directly on a printed circuit board (PCB). Further information is available upon request.

CONVERSIONS / AWG (AMERICAN WIRE GAUGE)



Circular wire					
AWG	Diameter		Cross-section mm ²	Weight kg / km	Max. resistance Ω / km
	Inch	mm			
10 (1)	0.1019	2.590	5.26	46.77	3.45
10 (37/26)	0.1150	2.921	4.74	42.10	4.13
12 (1)	0.0808	2.050	3.31	29.41	5.45
12 (19/25)	0.0930	2.362	3.08	27.36	6.14
12 (37/28)	0.0910	2.311	2.97	26.45	6.36
14 (1)	0.0641	1.630	2.08	18.51	8.79
14 (19/27)	0.0730	1.854	1.94	17.23	9.94
14 (37/30)	0.0735	1.867	2.08	18.870	10.50
16 (1)	0.0508	1.290	1.31	11.625	13.94
16 (19/29)	0.0590	1.499	1.23	10.928	15.70
18 (1)	0.0403	1.020	0.823	7.316	22.18
18 (19/30)	0.0052	1.321	0.963	8.564	20.40
20 (1)	0.0320	0.813	0.519	4.613	35.10
20 (7/28)	0.0390	0.991	0.563	5.003	34.10
20 (19/32)	0.0420	1.067	0.616	5.473	32.00
22 (1)	0.0253	0.643	0.324	2.883	57.70
22 (7/30)	0.0288	0.732	0.324	2.965	54.80
22 (19/34)	0.0330	0.838	0.382	3.395	51.80
24 (1)	0.0201	0.511	0.205	1.820	91.20
24 (7/32)	0.0250	0.635	0.227	2.016	86.00
24 (19/36)	0.0270	0.686	0.241	2.145	83.30
26 (1)	0.0159	0.404	0.128	1.139	147.00
26 (7/34)	0.0200	0.508	0.141	1.251	140.00
26 (19/38)	0.0220	0.559	0.154	1.370	131.00
28 (1)	0.0126	0.320	0.0804	0.715	231.00
28 (7/36)	0.0160	0.406	0.0889	0.790	224.00
28 (19/40)	0.0170	0.432	0.0925	0.823	207.00
30 (1)	0.0100	0.254	0.0507	0.450	374.00
30 (7/38)	0.0130	0.330	0.0568	0.505	354.00
30 (19/42)	0.0123	0.312	0.0720	0.622	310.00
32 (1)	0.0080	0.203	0.0324	0.288	561.00
32 (7/40)	0.0110	0.279	0.0341	0.303	597.10
32 (19/44)	0.0100	0.254	0.0440	0.356	492.00
34 (1)	0.0063	0.160	0.0201	0.179	951.00
34 (7/42)	0.0070	0.180	0.0222	0.197	1,491.00
36 (1)	0.0050	0.127	0.0127	0.1126	1,519.00
36 (7/44)	0.0060	0.150	0.0142	0.1263	1,322.00

The American Wire Gauge (AWG) is based on the principle that the cross-section of the wire changes by 26 % from one gauge number to the next. The AWG numbers decrease as the wire diameter increases, while the AWG numbers increase as the wire diameter decreases. This only applies to solid wire.

However, stranded wire is predominately used in practice. This has the advantage of a longer service life under bending and vibration as well as greater flexibility in comparison with solid wire.

Stranded wires are made of multiple, smaller-gauge wires (higher AWG number). The stranded wire then receives the AWG numbers of a solid wire with the next closest cross-section to that of the stranded wire. In this case, the cross-section of the stranded wire refers to the sum of the copper cross-sections of the individual wires.

Accordingly, strands with the same AWG number but different numbers of wires differ in cross-section. For instance, an AWG 20 strand of 7 AWG 28 wires has a cross-section of 0.563 mm², while an AWG 20 strand of 19 AWG 32 wires has a cross-section of 0.616 mm².

Source: ASTM

INTERNATIONAL COLOR CODE / IC-CODE

For UL / CSA multiconductor cables



Core	Core Color
1	Black
2	Brown
3	Red
4	Orange
5	Yellow
6	Green
7	Blue
8	Violet
9	Gray
10	White
11	White-Black
12	White-Brown
13	White-Red
14	White-Orange
15	White-Yellow
16	White-Green
17	White-Blue
18	White-Violet
19	White-Gray
20	Brown-Black
21	Brown-Red
22	Brown-Orange
23	Brown-Yellow
24	Brown-Green
25	Brown-Blue
26	Brown-Violet
27	Brown-Gray
28	Brown-White
29	Green-Black
30	Green-Brown

Core	Core Color
31	Green-Red
32	Green-Orange
33	Green-Blue
34	Green-Violet
35	Green-Gray
36	Green-White
37	Yellow-Black
38	Yellow-Brown
39	Yellow-Red
40	Yellow-Orange
41	Yellow-Blue
42	Yellow-Violet
43	Yellow-Gray
44	Yellow-White
45	Gray-Black
46	Gray-Brown
47	Gray-Red
48	Gray-Orange
49	Gray-Yellow
50	Gray-Green
51	Gray-Blue
52	Gray-Violet
53	Gray-White
54	Orange-Black
55	Orange-Brown
56	Orange-Red
57	Orange-Yellow
58	Orange-Green
59	Orange-Blue
60	Orange-Violet

- The cores are counted starting in the outer layer and continuing through all layers in the same direction.
The first color is the base color
- The 2nd and 3rd color is applied in the form of abrasion-resistant color rings.
For 2 and 3-colored cores, the characters of the color code are lined up directly next to each other
- For cables and single wires with color, the color code starts again with Black (1) from the 45th core onwards.
- For paired cores, always the two colors named in sequence are stranded.
- The color code is repeated from the 23rd and 45th pair onwards.

CURRENT LOAD OF TURNED CONTACTS



Nominal single contact current load for pin / slotted socket (nominal diameter 0.5 mm – 3.0 mm)

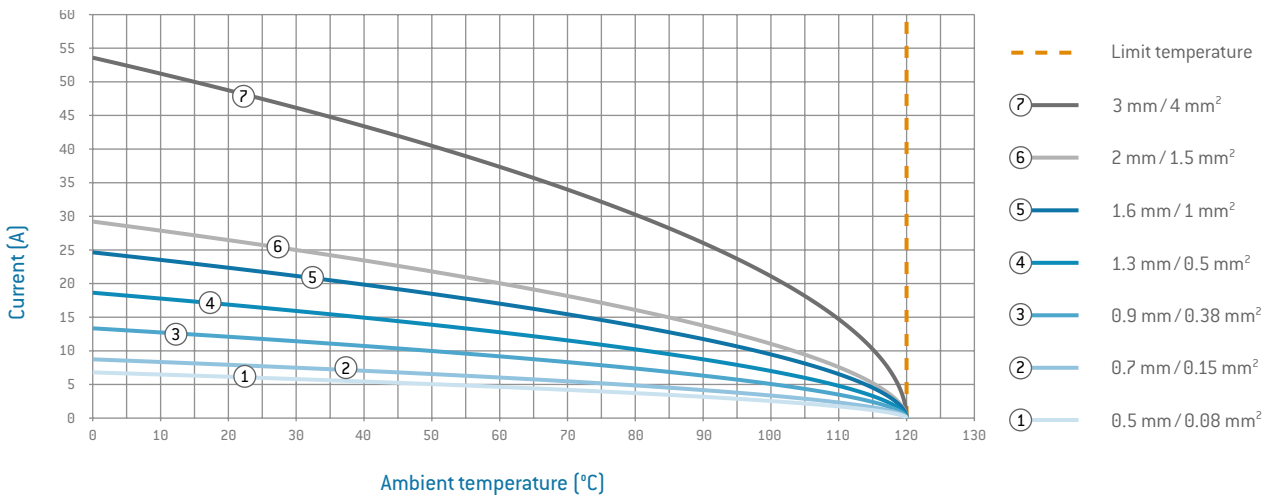
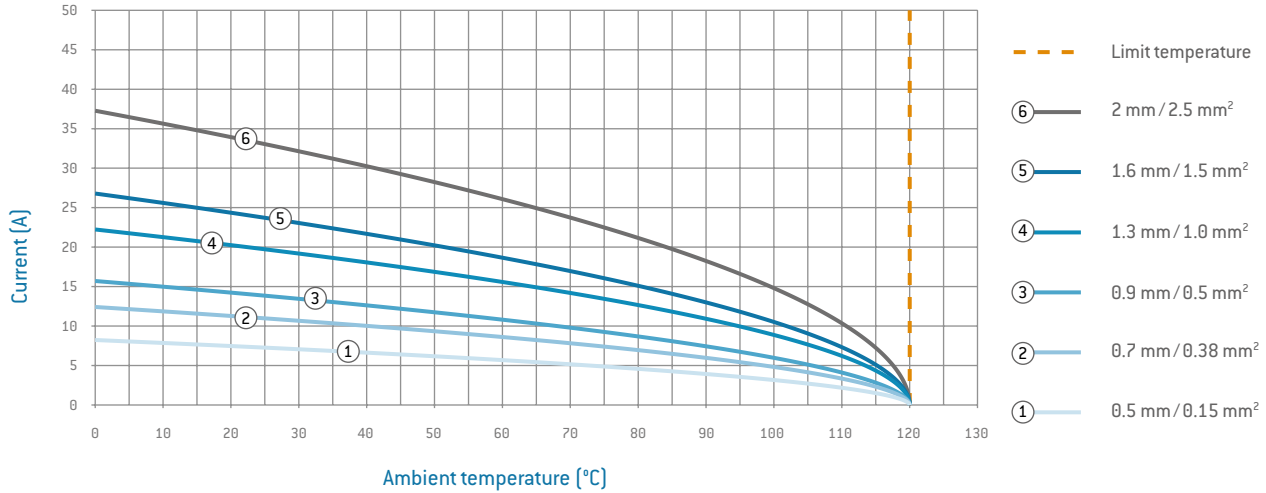

UPPER LIMIT TEMPERATURE OF STANDARD CONTACTS: +120 °C.

The measured current which flows through all contacts simultaneously and continuously when the largest permissible conducting wires are connected and the temperature at the contacts has increased by 45 Kelvin. The rated current is determined according to the Derating Measurement Method in accordance with IEC 60512-5-2:2002 (DIN EN 60512-5-2:2003) and derived from the Derating Curve.

DERATING CURVE

The corrected current-carrying capacity curve, derived from the base curve determined (0.8 x measured current). It factors in manufacturing tolerances as well as uncertainties in temperature measurement and measurement arrangement. See derating measurement method.

RATED CURRENT (NOMINAL CURRENT)

The measured current which flows through all contacts simultaneously and continuously when the largest permissible conducting wires are connected and the temperature at the contacts has increased by 45 Kelvin. The rated current is determined according to the Derating Measurement Method in accordance with IEC 60512-5-2:2002 (DIN EN 60512-5-2:2003) and derived from the Derating Curve.

DERATING FACTOR

Number of loaded wires	Derating factor
5	0.75
7	0.65
10	0.55
14	0.5
19	0.45
24	0.4

The derating curve for the cable assemblies depends on the individual combinations of contact diameter and cross-sections of the wires in the selected cable.

ELECTRO MAGNETIC COMPATIBILITY (EMC)

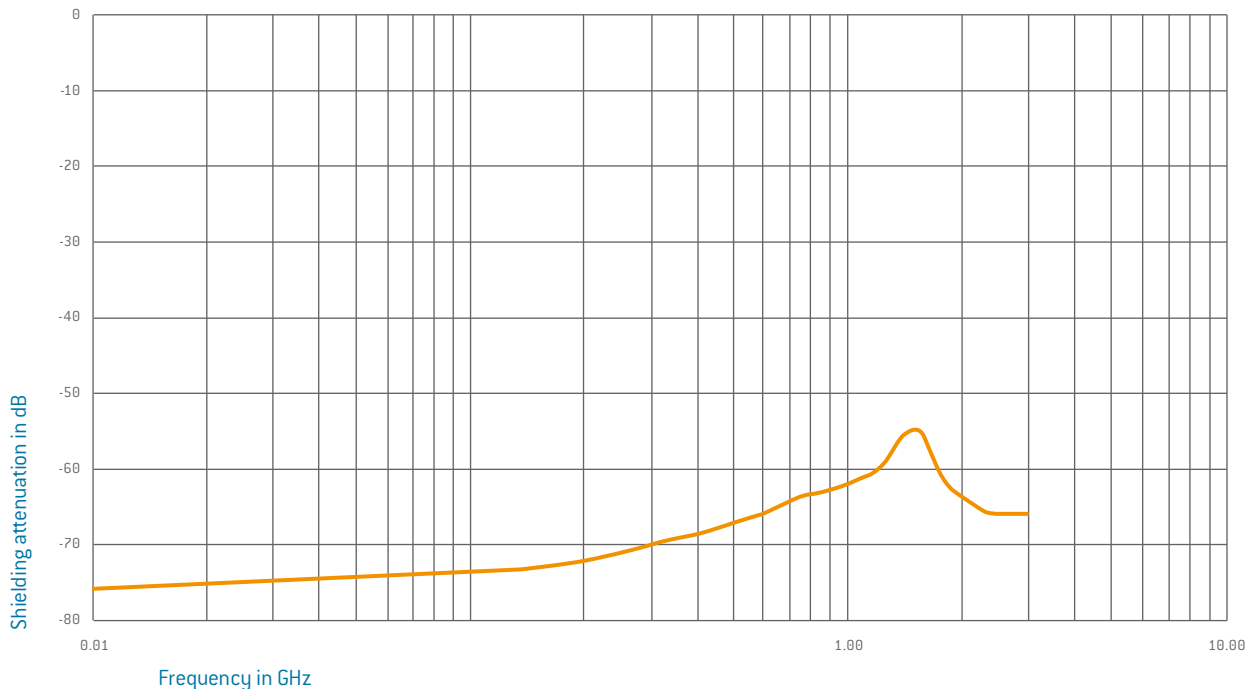

Electromagnetic compatibility (EMC) concerns more than just devices and electronic circuits. In the age of networks and data communication, connecting elements such as cables and connectors are also very important. Interference signals penetrating the connector from outside corrupt data signals and can cause significant system malfunctions. This can be reliably avoided with high-grade shielding for the cables and connectors. In order to give our customers certainty when using ODU MINI-SNAP® connectors, we've had a size 3 connector measured by an accredited EMC laboratory to determine its EMC quality. Since the sizes 0, 1 and 2 are identical to this connector in structure, just proportionally reduced in size, the values for shielding attenuation are the same.

The measurement was conducted according to the injection or parallel wire method pursuant to VG 95214-11:2002-11. The connector pair is connected with the receiver of a network analyzer on one end, while the other end receives an adjusted termination resistor. The injection wire is attached as closely as possible along the connector pair. A flat cable is usually used here, since an optimum adjustment can be achieved by attaching more or fewer wires. High-frequency signals in the 10 kHz to 3 GHz range are now fed in through the injection wire. The network analyzer measures the energy irradiated through the connector plug housing and into the connector, providing a shielding attenuation factor as the logarithmic performance ratio AT in dB. The important thing with this method is that all supply lines (especially the ones to the connector pair) must be very well shielded so that no interference signals can penetrate the measurement system and corrupt the measured values. This provides the shielding attenuation in dB as a curve over the logarithmically applied frequency.

Users frequently demand a shielding attenuation better than -55 dB (based on a requirement of Deutsche Post). It is clear that our connector meets this requirement over the entire measurement range.

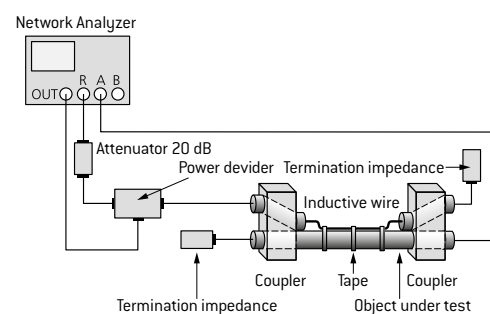

AUTOCLAVING OF ODU MINI-SNAP®



We can also provide ODU MINI-SNAP® connectors and cable assembly for the following sterilization procedures upon request: steam sterilization via pre-vacuum or gravity method. The connectors are tested in autoclaves for 500 cycles at 134 °C in accordance with DIN EN 13060:2019-02.

Please consult our technical team for the further sterilization procedure.

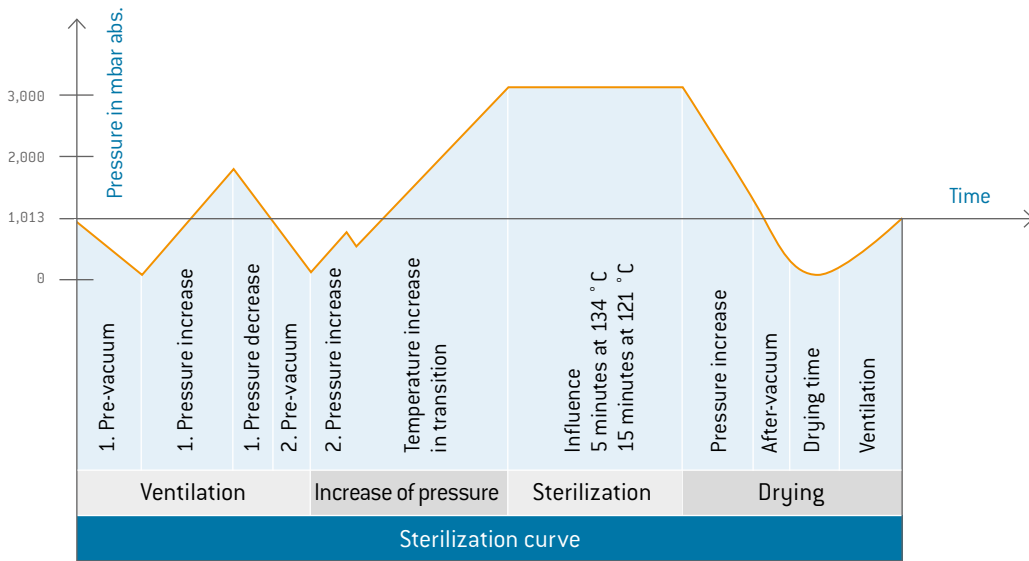

TECHNICAL TERMS



AMBIENT TEMPERATURE

Temperature of the air or other medium in which a connector or a corresponding cable assembly is intended to be used.

AUTOCLAVABILITY

See page [102](#).

AWG

American Wire Gauge (see page [98](#)).

BASE CURVE

A current-carrying capacity curve metrologically determined according to the method described in IEC 60512-5-2:2002 (DIN EN 60512-5-2:2003-01) depending on the permissible limit temperature of the materials. See page [100](#).

CHEMICAL RESISTANCE

Chemical resistance is the ability of a material to protect itself against chemical attack or solvent reaction. In contrast to corrosion, there is no material removal, which is particularly typical for plastics and elastomers.

Adhesives, cleaning agents or other chemicals are often used on our products within the scope of general deployment and further handling. Contact with unsuitable chemicals may have an adverse effect on the mechanical and electrical properties of the insulation and housing materials. The connector specifications may no longer be sustainable. Please observe our handling suggestions and technical instructions as given in this catalog or corresponding assembly instructions.

CLEARANCE DISTANCE

See page [93](#).

CODING (MECHANICAL)

Geometry detail that prevents interchangeability of otherwise identical connectors. This is useful when two or more identical connectors are attached to the same device, see page [23](#).

CONNECTORS

An element which enables electrical conductors to be connected and is intended to create and/or separate connections with a suitable counterpart (according to IEC 61984:2008 (VDE 0627:2009-11)). If not otherwise specified, these are connectors without breaking capacity (COC).

CONNECTOR WITHOUT BREAKING CAPACITY (COC)

Connector which is not deemed to be engaged or disengaged in normal use when live under load (according to IEC 61984:2008 (VDE 0627:2009-11)).

CONTACT RESISTANCE

The contact resistance is the contact resistance at the contact zone of a electrical contact pair. The contact resistance is significantly lower than the total resistance (refer to total resistance). The specifications are average values.

CORES

Electrical conductor, solid wire or multi-wire strand, with insulation as well as any conductive layers. Cables or leads may have one or more cores.

CREEPAGE DISTANCES

See page [93](#).

CRIMP BARREL

A terminal sleeve which can accommodate one or more conductors and be crimped by a crimping tool.

CRIMP CONNECTION (CRIMP TERMINATION)

The permanent, non-detachable and solder-free mounting of a contact to a conductor via deforming or shaping under pressure to make a good electrical and mechanical connection. Executed with crimping tool, press or automatic crimping machine (see page [84](#)).

CRIMPING AREA

The specified area of the crimp barrel in which the crimp termination is executed by means of deforming or shaping the barrel under pressure around the conductor.

DEGREE OF POLLUTION

Numerical value indicating the expected pollution of the micro-environment. The pollution levels 1-4 were defined. (Pollution: any deposit of solid, liquid or gaseous foreign matter that may reduce the electrical strength or surface resistance of the insulation; micro-environment: immediate vicinity of the insulation, which in particular influences the dimensioning of the creepage distances). See IEC 60664-1:2007 (VDE 0110-1:2008)). See page [92](#).



DELIVERY FORM

Connectors can be delivered in assembled form or as individual parts. Raw cables are not available without an assembled ODU connector.

DERATING CURVE

See page [100](#).

DERATING MEASUREMENT METHOD IEC 60512-5-2:2002 (DIN EN 60512-5-2:2003-01)

See page [100](#).

INSULATOR

Part of a connector which separates conductive parts with different potentials from one another; usually identical to the contact carrier.

LOWERMOST LIMIT TEMPERATURE

The lowest permissible temperature at which a connector may be operated. At ODU MINI-SNAP[®], it amounts to -40 °C . For cable assemblies, please see temperature range rating page [17](#).

MATERIALS (STANDARD MODEL)

See page [96](#).

INSERTION AND WITHDRAWAL FORCE

The force required to fully insert or withdraw pluggable elements without the influence of a coupling or locking device.

MATING CYCLES

A mating cycle consists of one insertion and withdrawal action of both connector parts with each other. The given values are only valid under the following conditions: clean environment, adequate radial alignment, flawless counter contact pins.

MAX. CONTINUOUS CURRENT

The metrologically determined amperage at room temperature (approx. 20 °C) which increases the contact temperature to the limit temperature. The values specified in the catalog apply to either individual contacts or completely assembled inserts / modules, as indicated. Refer to page [100](#) for the derating curve, if a different ambient temperature is valid.

NOMINAL SINGLE CONTACT CURRENT LOAD

The current-carrying capacity which each individual contact can be loaded with on its own (see page [100](#)).

NOMINAL VOLTAGE

The nominal voltage of the power source for which the connector is being used. The nominal voltage may not be higher than the rated voltage of the connector. For cable assemblies, please see temperature range rating page [17](#).

OPERATING TEMPERATURE FOR ODU MINI-SNAP[®]

Permissible temperature range between the uppermost and lowermost limits. This includes contact heating through current-carrying capacity (see page [9](#)). For cable assemblies, please see temperature range rating page [17](#).

OPERATING VOLTAGE

The operating voltage is the voltage supply at the device. The operating voltage may not be higher than the rated voltage of the connector, see page [93](#).

PCB (A.K.A. "PRINTED CIRCUIT BOARD")

A PCB is a carrier for electronic components. It serves the purposes of mechanical mounting and electrical connection.

PCB TERMINATION

A conductive connection between the PCB and an element in through-hole assembly, THT (through-hole technology).

RATED CURRENT (NOMINAL CURRENT)

See page [100](#).

RATED VOLTAGE

The rated voltage which the manufacturer specifies for a connector and which the operating and performance features relate to.

REDUCTION FACTOR

Based on VDE 0298-4:2013-06, connectors and cables with more than 5 contacts have a higher heating rate compared to individual contacts. For this reason, the aforementioned standard is calculated with a reduction.

SOLDER CONNECTION (SOLDER TERMINATION)

Termination technology in which a molten additional metal (solder) with a lower melting point than the base materials to be connected is used to attach two metallic materials to one another.

TECHNICAL TERMS



STRANDED WIRE

The stranded wire is an electrical conductor consisting of thin individual wires and is therefore easy to bend.

TIGHTNESS IEC 60529:2013 (VDE 0470-1:2014)

See protection classes on page [90](#).

TERMINATION CROSS-SECTION

The specified cross-sections correspond to a “fine-wire” conductor structure (7/19 wire) according to AWG (ASTM B258-14) or to a “fine-wire” conductor structure pursuant to IEC 60228:2005 (VDE 0295:2005; Class 5), borderline conductor structures require a separate review.

TERMINATION TECHNOLOGIES

Methods for connecting the leads to the electro-mechanical element, such as solder-free connections pursuant to IEC 60352 (DIN EN 60352): crimp, screw connection etc. or soldering connection (see page [97](#)).

TEST VOLTAGE

The test voltage which a connector or a corresponding cable assembly can withstand under defined conditions without dielectric breakdown or flashover.

For cable assemblies, please see temperature range rating page [17](#).

TOTAL RESISTANCE

Total resistance value measured from terminal to terminal (e.g. without crimp resistance). The specifications are average values.

UL, LLC (UNDERWRITERS LABORATORIES)

Is a global safety certification company and one of several companies approved to perform safety testing by the U.S. Federal agency, the Occupational Safety and Health Administration OSHA. It maintains a list of approved testing laboratories, which are known as Nationally Recognized Testing Laboratories.

UPPERMOST LIMIT TEMPERATURE

The maximum permissible temperature at which a connector may be operated. This includes contact heating through current-carrying capacity.

With ODU MINI-SNAP® standard ODU TURNTAC® contacts, this amounts to +120 °C. Please consult ODU for high-temperature applications.

WIRE

Solid conductor

GENERAL NOTE

The connectors and cable assemblies listed in this catalog are generally designed as connectors without breaking capacity unless otherwise stated. The rated voltage specification given on the respective data sheet must be respected.

Suitable precautionary measures must be taken to ensure that people do not come into contact with live conductors during installation and operation.

All entries in this catalog were thoroughly reviewed before printing. ODU reserves the right to make changes based on the current status of knowledge without prior notice and without being obliged to provide replacement deliveries or refinements of older designs.



Printed on certified recycled paper.

All dimensions are in mm.
Some figures are for illustrative purposes only. Subject to change without notice. Errors and omissions excepted. We reserve the right to change our products and their technical specifications at any time in the interest of technical improvement. This publication supersedes all prior publications.

ODU MINI-SNAP® SERIES F / C / 0523 / EN

This publication is also available as a PDF file that can be downloaded from www.odu-connectors.com